

PAS EX 1+9AP M10 V2A (472 420)

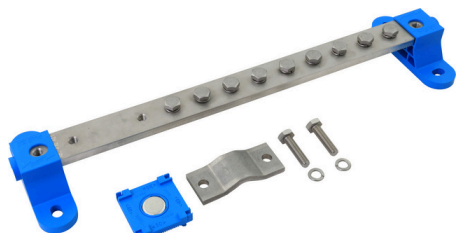
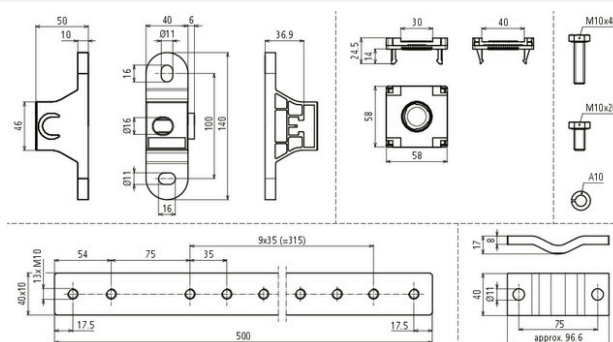

Figure without obligation



- For use in potentially explosive areas of Ex zones 1 and 2 (gases, vapours, mists) up to explosion group IIC as well as Ex zones 21 and 22 (dusts)
- Screws secured against self-loosening
- Both indoor and outdoor installation permissible

Type	PAS EX 1+9AP M10 V2A
Part No.	472 420 NEW
Connection Fl	1x flat conductor 30 / 40 mm
Connection cable lug	9x flexible / rigid conductor 16-95 mm ²
Material equipotential bonding bar	StSt
Screw material	StSt
Spring washer material	StSt
Saddle clamp material	StSt
Material No.	1.4301 / 1.4303
Insulator material	Polyamide / halogen-free, blue
Dimensions	522 x 140 x 65 mm
Bar	500 x 40 x 10 mm
Screws	☛ M10 x 40 mm / ☛ M10 x 20 mm
Screw type	with spring washer
Lightning impulse current (10/350 µs) StSt (V4A) 30x3.5 mm / 40x5 mm	2HExIIC 75 kA (non-sparking) T4
Lightning impulse current (10/350 µs) StSt (V4A) 30x3.5 mm / 40x5 mm	H 100 kA
Lightning impulse current (10/350 µs) St/tZn 30x3.5 mm/40x5 mm	1HExIIC 100 kA (non-sparking) T4
Lightning impulse current (10/350 µs) Cu 16-95 mm ²	1HExIIC 100 kA (non-sparking) T4
Max. short-circuit current (AC 50 Hz / DC / 5 s) StSt (V4A) 30x3.5 mm / 40x5 mm	750 A / T4
Max. short-circuit current (AC 50 Hz / DC / 5 s) St/tZn 30x3.5 mm / 40x5 mm	1500 A / T4
Max. short-circuit current (AC 50 Hz / DC / 5 s) Cu 16 mm ²	750 A / T4
Max. short-circuit current (AC 50 Hz / DC / 5 s) Cu 95 mm ²	3.1 kA / T4
Max. surface temperature T4	135 °C
Type	UV-stabilised
Standard	IEC 62561-1 / CLC 50703-2
Weight	2,28 kg
Customs tariff number	85389099
GTIN	4013364476059
PU	1 Stk

With regard to corrosion resistance, it must be checked whether the materials used for the PAS EX (e.g. Cu/galSn, StSt, polyamide, polyurethane ester) can be used in the existing ambient conditions.

We reserve the right to introduce changes in performance, configuration and technology, dimensions, weights and materials in the course of technical progress. The figures are shown without obligation.