

# Connection System for LINEARlight Flex & TEC Flex® IP00

CONN-FLEX-2P-050 KIT 10PCS  
EAN 4062172179591

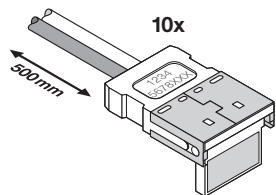

CONN-FLEX-2P-200 KIT 10PCS  
EAN 4062172179614

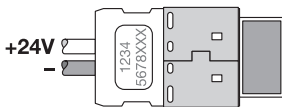
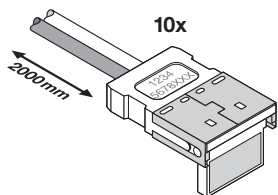

CONN-FLEX-3P-050 KIT 10PCS  
EAN 4062172179690

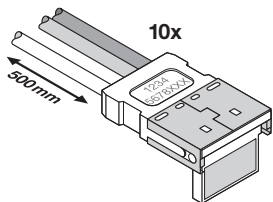

CONN-FLEX-3P-200 KIT 10PCS  
EAN 4062172179720

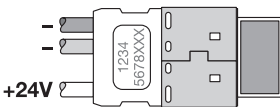
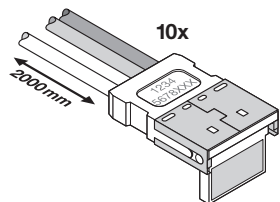

CONN-FLEX-4P-050 KIT 10PCS  
EAN 4062172179744

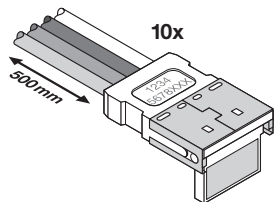

CONN-FLEX-4P-200 KIT 10PCS  
EAN 4062172179768

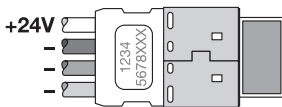
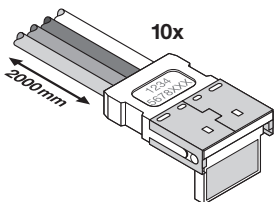

CORNER-FLEX-4P-015 KIT 10PCS  
EAN 4062172179676

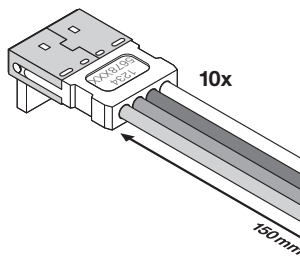

CORNER-FLEX-4P-003 KIT 10PCS  
EAN 4062172179638

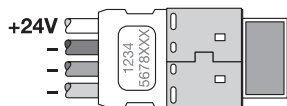
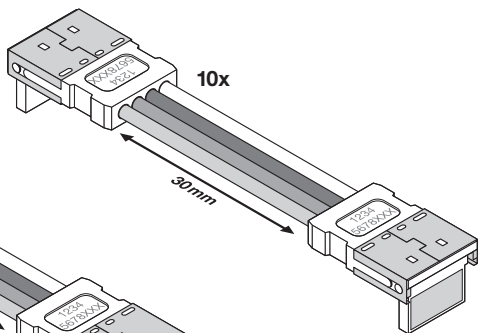

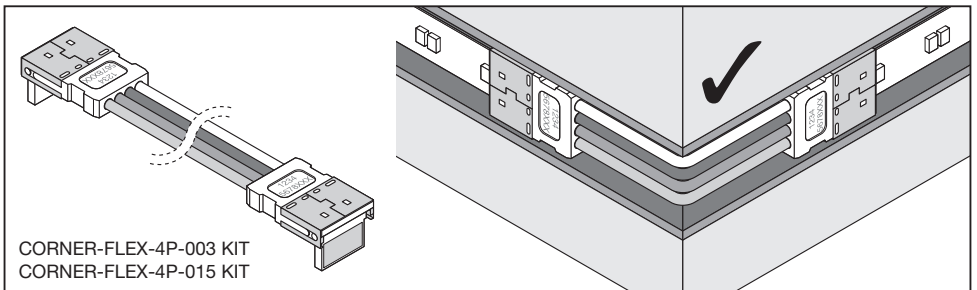
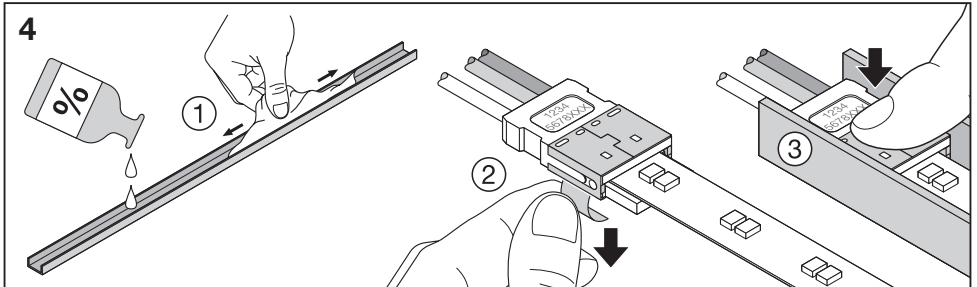
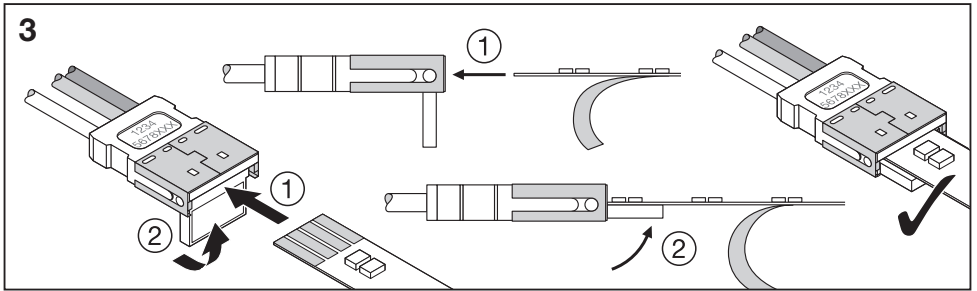
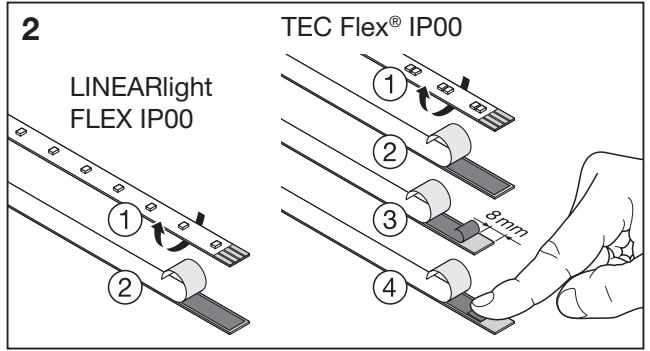
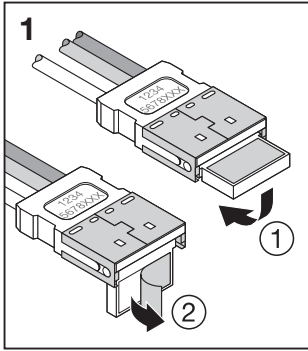

C10238698  
G15091839  
10.12.20

OSRAM GmbH  
Berliner Allee 65  
86153 Augsburg  
Germany  
[www.osram.com](http://www.osram.com)