

PRODUCT DATASHEET

DL ALU DN 200 25 W 3000 K IP44/IP20 WT

DOWNLIGHT ALU | Downlight luminaires with aluminum housing



Areas of application

- Direct replacement for luminaires with compact fluorescent lamps
- General illumination
- Public areas
- Stairways
- Corridors
- Foyers
- Shops

Product benefits

- High luminous efficacy
- Energy savings up to 60 % (compared to luminaires that use CFL lamps)
- Very homogenous light
- Functional design
- Easy installation with fast connection
- External driver for extended flexibility (compatible with selected DALI drivers)
- 5 years guarantee

Product features

- Diameter of required ceiling cut-out: 150 mm or 200 mm (depending on version)
- Type of protection: IP44



TECHNICAL DATA

Electrical data

Nominal wattage	25.00 W
Nominal voltage	220...240 V
Mains frequency	50...60 Hz
Nominal current	110 mA
Inrush current	7 A
Inrush current time T_{h50}	100 μ s
Max. number of luminaires per miniature circuit breaker B16	107
Max. number of luminaires per miniature circuit breaker C10	72
Max. number of luminaires per miniature circuit breaker C16	116
Power factor λ	> 0.90
Total harmonic distortion	< 20 %
Protection class	II
Operating mode	External LED driver

Photometrical data

Luminous flux	2250 lm
Luminous efficacy	90 lm/W
Color temperature	3000 K
Light color (designation)	Warm White
Color rendering index Ra	> 80
Standard deviation of color matching	≤ 6 sdc _m
Luminous intensity	-
Flickering metric (Pst LM)	-
Stroboscope effect metric (SVM)	-
Photobiological safety group acc. to EN62778	RG0
Photobiological safety group acc. to EN62471	RG0
Beam angle	100 °

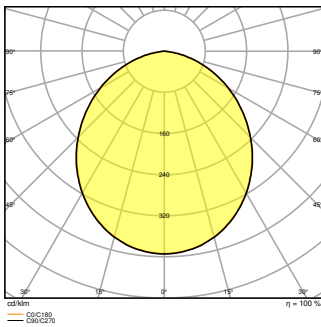

DL ALU DN200 25W 3000K WT
IP44

Dimensions & Weight

Diameter	215.00 mm
Height	61.00 mm
Product weight	600.00 g

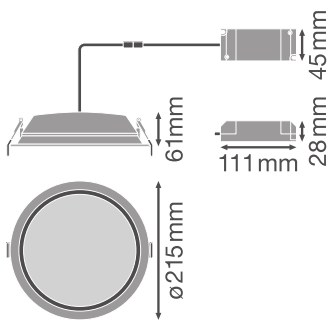

DL ALU DN200

Materials & Colors

Product color	White
Housing color	White
Body material	Aluminum
Cover material	Polymethylmethacrylate (PMMA)
Glow Wire Test according to IEC 60695-2-12	650 °C

Application & Mounting

Ambient temperature range	-20...+45 °C
---------------------------	--------------

Temperature range at storage	-20...+80 °C
Type of connection	Screwless terminal, 2-Pole
Type of protection	IP44/IP20
Protection class IK (shock resistance)	IK02
Dimmable	No
Mounting type	Recessed
Mounting location	Ceiling
Application environment	Indoor
Mounting diameter	200 mm
Mounting depth	120 mm
With light source	Yes

Lifespan

Lifespan L70/B50 at 25 °C	50000 h ¹⁾
Lifespan L80/B10 at 25 °C	45000 h ¹⁾
Lifespan L80/B50 at 25 °C	45000 h
Lifespan L90/B10 at 25 °C	30000 h
Number of switching cycles	100000

¹⁾ t[h]: L70 / B50 @ 25 °C (Ta), t[h]: L80 / B10 @ 25 °C (Ta), t[h]: L90 / B10 @ 25 °C (Ta)

Control gear

Output current	550 mA
ECG - Output ripple current	< 30 %
ECG - Length	111 mm
ECG - Width	45 mm
ECG - Height	28 mm

Certificates & Standards

Standards	CE / CB / ENEC / TÜV SÜD
Luminaire with limited surface temperature, "D sign"	No
Ball shot safe	No
Replaceable light source (EPREL)	Not replaceable

Additional product data

Number of illuminants	Not relevant
-----------------------	--------------











Accessories Optional





Product image	Product name	EAN
	EM CONVERSION BOX	4058075237025

Safety advice

- All electrical connections must be made by a qualified person.
- Caution, risk of electric shock.
- The luminaires are not suitable for covering with thermally insulated material.

DOWNLOAD DATA

	Documents and certificates	Document name
	User instruction / safety instructions	UI Downlight ALU
	On-Pack-Info	Legal Insert Downlight LED ALU+Comfort
	Legal information	LSI DL ALU
	Legal information	Informationstext 18 Abs 4 ElektroG
	Declarations of conformity	EU Declaration of Conformity DOWNLIGHT ALU LEDV
	Declarations of conformity	CE-Certificate Downlight ALU TUV
	Declarations of conformity UKCA	UKCA Declaration of Conformity DL ALU WT IP44
	Photometric and lighting design files	Document name
	IES file (IES)	DL ALU DN200 25W 3000K WT IP44
	LDT file (Eulumdat)	DL ALU DN200 25W 3000K WT IP44
	ULD file (DIALux)	DOWNLIGHTALU20025W3000KIP44WT
	ROLF file (RELUX)	DL ALU DN200 25W-3000K

Photometric and lighting design files		Document name
	UGR file (UGR table)	DL ALU DN200 25W 3000K WT IP44
	Light distribution curve type polar	DL ALU DN200 25W 3000K WT IP44
CAD/BIM files		Document name
	BIM Revit 3D	Downlight ALU
	CAD STEP 3D	DL ALU 25W 35W
Tender texts		Document name
	Tender documents	DOWNLIGHT ALU 200 25 W 3000 K IP44IP20 WT-EN

LOGISTICAL DATA

Product code	Packaging unit (Pieces/Unit)	Dimensions (length x width x height)	Gross weight	Volume
4058075091498	Folding box 1	225 mm x 225 mm x 110 mm	775.00 g	5.57 dm ³
4058075091504	Shipping box 8	462 mm x 462 mm x 240 mm	6870.00 g	51.23 dm ³

The mentioned product code describes the smallest quantity unit which can be ordered. One shipping unit can contain one or more single products. When placing an order, for the quantity please enter single or multiples of a shipping unit.

ADDITIONAL CATALOG INFORMATION

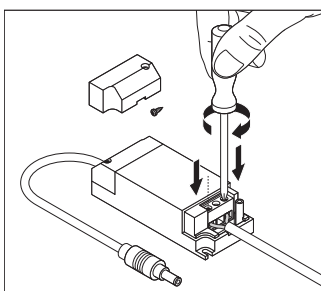

References / Links

– For Guarantee see www.ledvance.com/guarantee

DISCLAIMER

Subject to change without notice. Errors and omission excepted. Always make sure to use the most recent release.