

Screw terminal block 4mm² with
60V suppressor diode, beige color

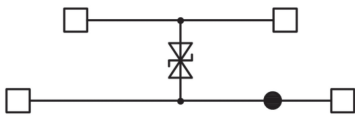

Series	DAS
Code	DSD060
Type	DAS.4/D60
HS code	85369010
Colour	Beige
TECHNICAL FEATURES	
Function/Type	With transient voltage suppressor
Rated cross-section	4 mm ²
Connecting capacity	
Flexible wire	0.2-6 mm ²
Rigid wire	0.2-6 mm ²
Wire with ferrule - ferrule type	4 mm ² – WP40/16
Electrical characteristics according to IEC EN standard	
Maximum voltage AC/DC	630 V (1)
Maximum current (rated cross-section)	30 A (1)
Caliber	A4
Electrical characteristics according to UL Standard	
Electrical characteristics according to ATEX directive and IEC Ex standard	
Type of component	Suppressor diode – 1.5KE75CA
Rated voltage	60 V (max. 77.9 Vdc)
Breakdown voltage (1mA)	82 V ± 5%
Max clamping voltage / response time	113 V / < 1 ns
Isc pulse (8/20 µs)	70 A
Rated impulse withstand voltage / pollution degree	– / 3
Insulation stripping length	9 mm
Tightening torque value (nom. / max.)	0.5 / 1.2 Nm
Width (pitch)	6 mm
Length	64 mm
Height mounted on TH35-7.5/TH35-15/G32	62 / 70 / 66 mm
Insulation material temperature index (EN 60216-1)	130 °C
Plastic material	Polyamide UL94V-0
ACCESSORIES	
End section	
Grey	DAS/PT/GR (cod. DS101GR)
Blue	DAS/PT (Ex)i (cod. DS201)
Beige	DAS/PT (cod. DS101)
Thickness	1.5 mm
Cross-connection	
Model A)	PM/.../... (cod. PM...)
Model B)	–
Rated current carrying capacity IEC/ATEX	30 A / –
Cross-connection identification strip	–
Internal removable cross-connection	DAS/VCI (cod. DS107) – DAS/VCE (cod. DS108)
Switchable cross-connection	POS/43 (cod. POS43)
Multiple cross-connection bar	PMP/58 (cod. PMP58)
Shunting screw and sleeve (Standard / Exe)	CPM/01 (cod. CPM01) – CPX/01 (cod. CPX01)
Protection cover	PRP/5 (cod. PRP05)
Coloured partition plate	DFU/7/R (cod. DU07R)
Test plug socket	SDD/1 (cod. DD001) – PSD/A (cod. PD001)
Screw and plate for short-circuit	
Marking	
Single marking tag	CNU/8/61 (cod. NU0861S)
Single marking tag for pitch insertion	CNU/8/61 (cod. NU0861S)
End bracket	
TH35 screw type	BT/3 (cod. BT003)
TH35 snap-fit type	BTO (cod. BT007)
TH35 and G32 snap-fit type	BTU (cod. BT005)
Mounting rail	
IEC 60715/TH35	PR/3/...
IEC 60715/G32	PR/DIN/...
APPROVALS AND MARKINGS	

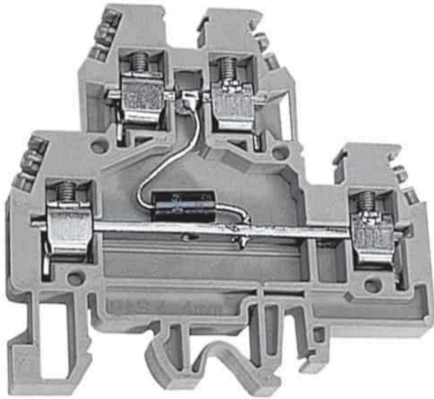
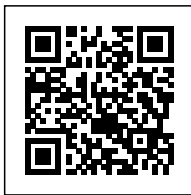

* With bidirectional TVS against overvoltages and transient* Classe D protection according to DIN VDE 0678* 1.5 kV overvoltage category* Cross connection available on lower level
1 For more details on accessories, refer to the relevant chapters2 (1) Value referred to the terminal blocks

DESCRIZIONE DEL PRODOTTO

DAS.4/D60 Screw
terminal block 4mm² with 60V suppressor diode, beige color