



# Modicon X80 module platform

The common platform of modules for Modicon M580 and M340 PLCs/PACs



# Modicon

## Discover [Modicon](#)

Edge control for Industrial IoT

Modicon IIoT-native edge controllers manage complex interfaces across assets and devices or directly into the cloud, with embedded safety and cybersecurity. Modicon provides performance and scalability for a wide range of industrial applications up to high-performance multi-axis machines and high-available redundant processes.

## Explore our offer

- [Modicon HVAC Controllers](#)
- [Modicon PLC](#)
- [Modicon Motion Controllers](#)
- [Modicon PAC](#)
- [Modicon I/O](#)
- [Modicon Networking](#)
- [Modicon Power Supply](#)
- [Modicon Wiring](#)
- [Modicon Safety](#)

Life Is On



# Quick access to product information

## Get technical information about your product

References

**Modicon TM3**  
I/O expansion modules for Modicon controllers  
Analog I/O modules

Number and type of channels	Input range	Output range	Resolution	Input terminal (mm)	Reference	Weight (g)
2 enhancement inputs	-10...+10 VDC 0...20 mA, 4...20 mA	0...12 VDC 0...12 mA	10 bits or 10 bits + sign	25.4	TM3AI2H	1,150
4 enhancement inputs	-10...+10 VDC 0...20 mA, 4...20 mA	0...12 VDC 0...12 mA	10 bits or 10 bits + sign	25.4	TM3AI4H	1,150
4 enhancement or temperature inputs	-10...+10 VDC 0...20 mA, 4...20 mA	0...12 VDC 0...12 mA	10 bits or 10 bits + sign	25.4	TM3AI4T	1,150
4 differential temperature inputs	-10...+10 VDC 0...20 mA, 4...20 mA	0...12 VDC 0...12 mA	10 bits or 10 bits + sign	25.4	TM3AI4D	1,150

Each commercial reference presented in a catalog contains a hyperlink. Click on it to obtain the technical information of the product:

- Characteristics, Dimensions and drawings, Mounting and clearance, Connections and schemas, Performance curves
- Product image, Instruction sheet, User guide, Product certifications, End of life manual

## Find your catalog

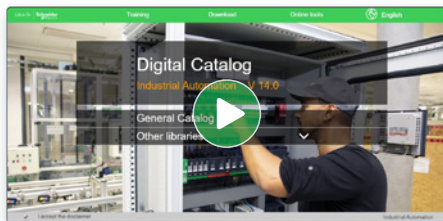

- > With just 3 clicks, you can access the Industrial Automation and Control catalogs, in both English and French
- > Consult digital automation catalogs at [Digi-Cat Online](#)

- Up-to-date catalogs
- Embedded product selectors, 360° pictures
- Optimized search by commercial references

## Select your training



- > Find the right [Training](#) for your needs on our Global website
- > Locate the training center with the selector tool, using this [link](#)

# General contents

Modicon X80 offer presentation .....	1
Racks .....	2
Power supplies .....	3
I/O modules.....	4
Safety.....	5
Expert modules .....	6
I/O expansion modules .....	7
Communication modules .....	8
Dedicated parts for severe environments .....	9
Standards and certifications, Services, Index ...	10

In this catalog, all instances of words that refer to Safety without precision must be understood as referring to "Functional Safety" according to IEC 61508 and IEC 61511.

Schneider Electric's IoT-enabled, plug-and-play, open, secure, interoperable architecture and platform, in Industries, Infrastructures, Data Centers, and Buildings.

### Innovation at every level

EcoStruxure is based on a three-tiered technology stack delivering innovation at every level, from connected products to edge control and apps, analytics, and services.

Together with our hybrid segments approach, this enhances your value around safety, reliability, operational efficiency, sustainability, and connectivity across 6 domains of expertise:

- Power
- IT
- Building
- Machine
- Plant
- Grid

### Dedicated architectures and IoT

We tailor our solutions in the form of dedicated reference architectures for plants:

- Management systems
- Power systems
- Data center systems
- Industrial plant and machine systems
- Smart grid systems

The Industrial Internet of Things (IIoT) gives an additional boost to technologies. That's why we provide our customers with an IoT-enabled architecture and platform offering simple, reliable, productive, and cost-efficient solutions.

### Cybersecurity solutions

Robust cybersecurity protection is a must, and Schneider Electric's solutions can deliver it, regardless of business type or industry.

The vendor-agnostic services provided by our skilled professionals help to protect your entire critical infrastructure. We help to assess your risk, implement cyber-specific solutions, and maintain your onsite defenses over time, while integrating appropriate IT policies and requirements.

This is our difference and your advantage.

### Enhanced safety

With the release of M580 Safety, Schneider Electric further expands the EcoStruxure platform.

This consolidates our position as one of the most trusted industrial safety vendor, with thousands of Modicon and Triconex safety systems protecting the most critical industrial processes globally.

**EcoStruxure™** for Plant  
Innovation At Every Level

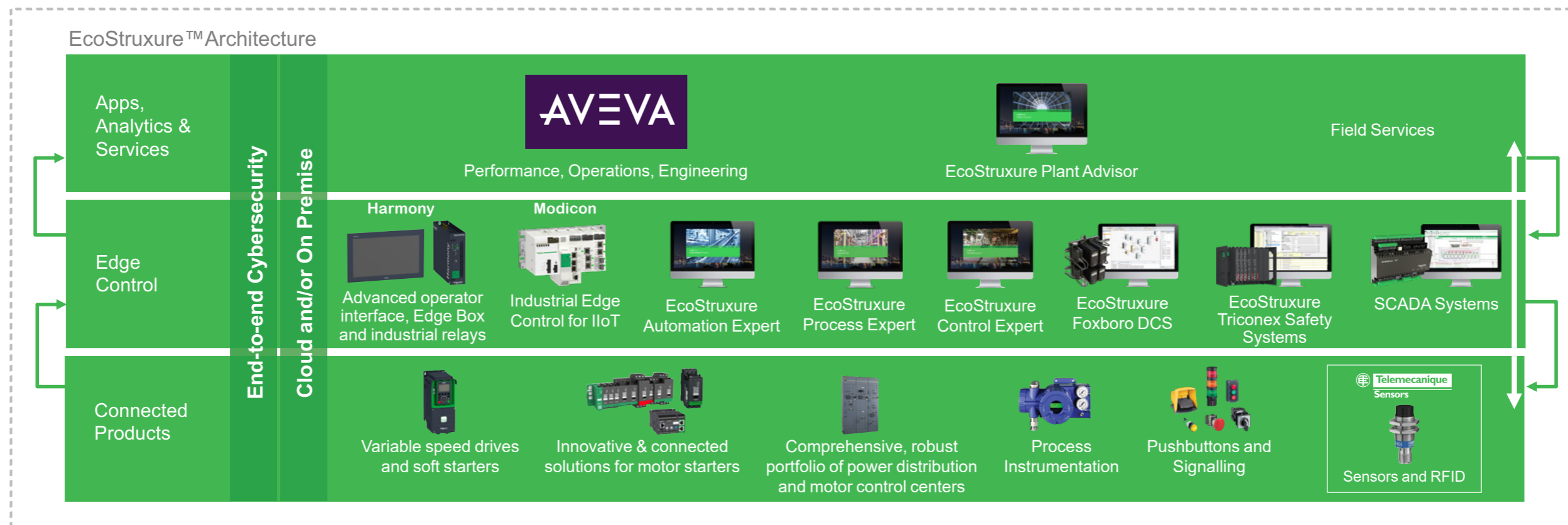

\*The Schneider Electric industrial software business and AVEVA have merged to trade as AVEVA Group plc, a UK listed company. The Schneider Electric and Life is On trademarks are owned by Schneider Electric and are being licensed to AVEVA by Schneider Electric.



---

## Modicon X80 offer presentation

- Overview ..... [page 1/2](#)
- Composition ..... [page 1/6](#)
- Product compatibility according to network architecture and platform ..... [page 1/8](#)



# Modicon X80 module platform

Compact, robust, sustainable

1

## Modicon X80 modules

Common in-rack modules for Modicon M580 and Modicon M340



Modicon X80 modules serve as the common in-rack I/O, experts, and communication modules for Modicon M580 and Modicon M340 PAC platforms. This range also includes power supplies, racks and accessories common to both ranges.

A wide choice of modules is available to meet the needs of Hybrid industries and critical infrastructures.

- > Modicon X80 modules can be used in remote racks with an I/O expansion module in Modicon M580 architectures. This forms a Modicon X80 RIO Drop.
- > Modicon X80 modules can also be used in distributed architectures building X80 DIO Drops.

This single common offer helps customers to reduce their stocks of spare parts. It also decreases maintenance and training costs. Modicon X80 in-rack I/O modules provide a high level of services such as bit forcing, device DDT, change configuration over the fly and are natively integrated into EcoStruxure control Expert (1), the programming environment for Modicon M580 and Modicon M340.

### Compact

- > The Modicon X80 module platform features the latest I/O technology, making it extremely compact.
- > It has smaller cabinet dimensions, with up to 64 discrete I/O for some modules.
- > High density



Modicon X80 module platform

### Robust

- > Offering more than required by the standards

Characteristics	Modicon X80 module platform	IEC standards Required by
<b>Mechanical constraints</b>	<b>Levels reached</b>	<b>IEC 60068-2</b>
Shock	30 g	> 15 g
Vibrations	3 g	> 1 g
<b>Electrical immunity</b>	<b>Levels reached</b>	<b>IEC 61131-2</b>
Radiated field	15 V/m	> 10 V/m
Electrostatic discharges by contact	6 kV	> 4 kV
<b>Environmental immunity</b>	<b>Working values</b>	<b>IEC 61131-2</b>
Temperature	0...60 °C/32... 140 °F	> 5...55 °C/41... 131 °F
Modicon X80 ruggedized offer	-25...70 °C/32... 158 °F	> 5...55 °C/41... 131 °F
<b>Corrosive environments (coated versions)</b>		<b>Class Gx, 3C4, Kb, 3S4, 3B2</b>

### Sustainable

- > Common X80 modules reduce training and maintenance costs
- > Hot swappable
- > Existing solutions for migrating from legacy I/O to the Modicon X80 module platform
- > Green Premium Eco Label

(1) EcoStruxure Control Expert software continues the Unity Pro range of software and corresponds to versions ≥ 14 of Unity Pro.

## + Common platform



M580 Safety

Regulatory requirements



Good practices dictate that control systems must be designed to keep process control functions separate and operationally independent from safety functions. This is usually achieved using a controller for the process and a separate system for safety.

Clear distinction between safety and process

Our solution to combine safety and process management in one application

- > Dual processing capability to control safety and process functions independently
- > Unifying independent plant safety and process control to help protect the entire operating environment
- > Minimized impact of standard process failure on plant safety, its people, and assets
- > No need to design, install, and maintain separate safety systems
- > Same tools, wiring methods, and I/O structures as Modicon M580 controller

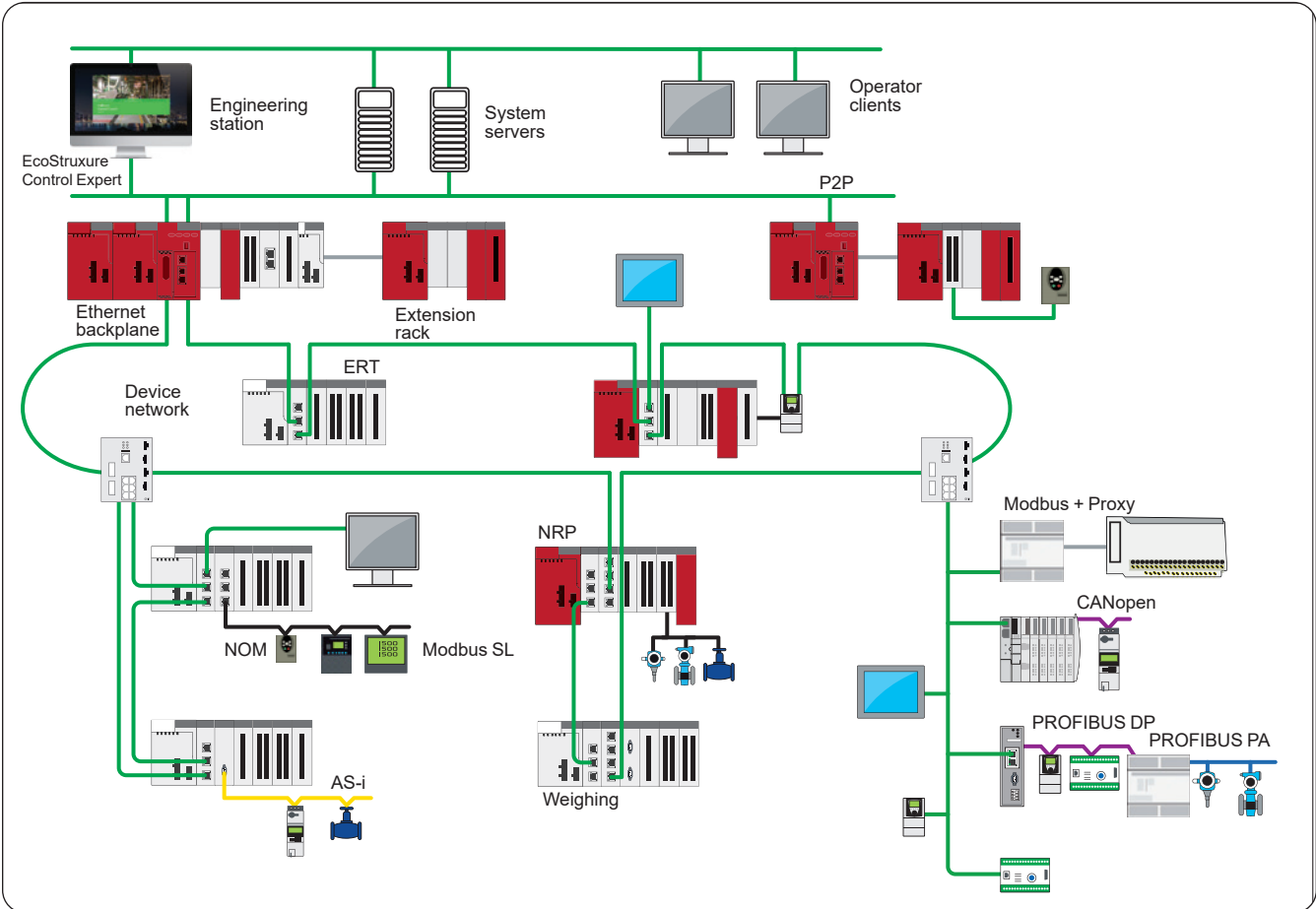

Typical common Safety architecture with Modicon M580 Safety

+ Combining standard process and safety in a single M580 project

1



### Certifications and standards

Depending on the model, Modicon X80 modules comply with the following standards:

- > International certifications: CE, UL, CSA, RCM, EAC, UKCA
- > Certified for Hazardous Location Class I Division 2 Groups ABCD and for ATEX/UKEX/IECEx zone 2/22 (depending on the model, see [pages 10/2 to 10/3](#))
- > Merchant navy: IACS E10 and agencies: ABS, BV, DNV, GL, LR, RINA, RMRS, and CCS
- > Power generation market: IEC 61000-6-5, IEC 61850-3
- > See [pages 10/2 to 10/3](#) for more information.

#### International certifications



#### Merchant navy



#### Hazardous locations



#### Functional safety





### Market segments

> The Modicon PAC platforms (Modicon M340 and Modicon M580) supported by common Modicon X80 modules are suited to fulfill the requirements of following vertical segments:



Water & waste water



Mining, minerals & metals



Consumer Packaged Goods



Oil & gas



Power generation



Discrete manufacturing



Transportation



Tunnels



Data centers



### Presentation

Modicon X80 modules serve as the common in-rack I/O, expert, and communication modules for Modicon M580 and Modicon M340 PAC platforms. This range also includes power supplies, racks and accessories common to both ranges.



Modicon M580 platform



Modicon M340 platform

Modicon X80 modules may also:

- Form part of a Modicon M580 Ethernet I/O architecture as an Ethernet RIO (EIO) drop with X80 Remote I/O drop adapter;



In progress: all Modicon products in grey



Modicon X80 RIO drop for Modicon M580 Ethernet I/O architecture

- Form an Ethernet Modbus/TCP DIO drop with X80 Peripheral remote I/O adapter.



Modicon X80 DIO drop

The Modicon X80 module platform is available in single-rack or multi-rack configuration. One Modicon X80 RIO drop may support two racks separated by a cumulative distance of up to 30 m/98 ft.

This platform, common to several automation platforms, can reduce maintenance and training costs as it comprises:

- a single range of spare parts in stock
- training common to several PLCs

Based on the latest I/O technology, the Modicon X80 module platform offers:

- high-quality ruggedness and compactness
- compliance with international certifications (ATEX, IEC, etc.)
- a wide selection of modules: discrete or analog I/O modules, expert modules, communication modules, etc.

Bit forcing simplifies simulation and structured data simplifies diagnostics.

(1) See the compatibility guide on [page 1/8](#).

### Description

#### Modicon X80 module platform

- 1 X-bus racks with 4, 6, 8, or 12 slots or Ethernet + X-bus racks with 4, 8, or 12 slots for single power supply, and Ethernet + X-bus racks with 6 or 10 slots for dual power supply
- 2 AC or DC power supply modules
- 3 Discrete and analog I/O modules
- 4 RTU (remote terminal Unit) serial link, AS-Interface, and other communication modules
- 5 Empty slot to integrate CPU or I/O expansion module.

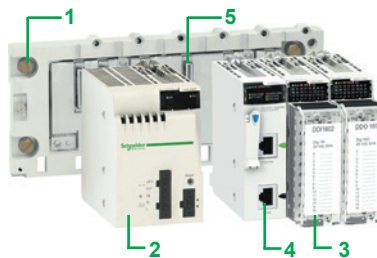

Typical basic assembly with Modicon X80 I/O modules

Modicon X80 offer extends to:

- **X80 I/O modules**, including HART I/O
- **X80 Expert modules** such as counter, motion control, SSI encoder, time-stamping, frequency input modules, and additional TPP (1) module for weighing
- **X80 Communication modules** for AS-Interface, Modbus, CANopen, PROFIBUS DP communication, and additional devices such as fiber converter modules and Ethernet network switch module
- **X80 I/O expansion modules**: Remote I/O drop and Peripheral remote I/O drop adapters

Modicon M580 and Modicon M340 automation platforms also include specific communication modules that are described in the related catalog:



[DIA6ED2151012EN](#)



[DIA6ED2110104EN](#)

### Treatment for severe environments

With “ruggedized” modules, the Modicon X80 module platform may be used in harsh environments or within a range of operating temperatures from -25 to +70 °C / -13 to +158 °F (see [page 9/2](#)).

(1) Technology Partner Program

# Modicon M580/M340/X80 platforms

Product compatibility according to network architecture and platform

For safety product compatibility, please refer to [page 5/4](#)

Product type	Commercial reference (1)	Module type	M340		M580						M580 + M340		
			Local rack with CPU				X80 drops on Ethernet remote I/O						X80 drops on distributed I/O
			Standalone		Redundant		Standalone or redundant X-bus rack BMXXBP●●●●		Standalone		Redundant		X-bus rack BMXXBP●●●●
			X-bus rack (2) BMXXBP●●●●	X-bus + Ethernet rack BMEXBP●●●●	X-bus rack (2) BMXXBP●●●●	X-bus + Ethernet rack BMEXBP●●●●	BMXCRA31200	BMXCRA31210	BMECRA31210		BMXPRA0100		
Power supplies	BMXCPS2000	X80 Power supply											
	BMXCPS2010	X80 Power supply											
	BMXCPS3020 (H)	X80 Power supply											
	BMXCPS3500 (H)	X80 Power supply											
	BMXCPS3540T	X80 Power supply											
	BMXCPS4002 (H)	X80 Redundant power supply											
	BMXCPS4022 (H)	X80 Redundant power supply											
	BMXCPS3522 (H)	X80 Redundant power supply											
Backplanes	BMXXBP0400 (H)	X80 X-bus backplane											
	BMXXBP0600 (H)	X80 X-bus backplane											
	BMXXBP0800 (H)	X80 X-bus backplane											
	BMXXBP1200 (H)	X80 X-bus backplane											
	BMXXBE1000 (H) (3)	X80 X-bus rack expansion module											
	BMXXBE2005 (4)	X80 X-bus rack expansion kit											
	BMEXBP0400 (H)	X80 X-bus+Eth backplane											
	BMEXBP0800 (H)	X80 X-bus+Eth backplane											
	BMEXBP1200 (H)	X80 X-bus+Eth backplane											
	BMEXBP0602 (H) (5)	X80 X-bus+Eth dual power supplies backplane											
	BMEXBP1002 (H) (5)	X80 X-bus+Eth dual power supplies backplane											
	BMXXEM010 (6)	Protective cover											
	I/O	BMXAMI0410 (H)	X80 Analog I/O										
BMXAMI0800		X80 Analog I/O											
BMXAMI0810 (H)		X80 Analog I/O											
BMXAMM0600 (H)		X80 Analog I/O											
BMXAMO0210 (H)		X80 Analog I/O											
BMXAMO0410 (H)		X80 Analog I/O											
BMXAMO0802 (H)		X80 Analog I/O											
BMXART0414 (H)		X80 Analog I/O											
BMXART0814 (H)		X80 Analog I/O											
BMEAH0812 (H)		X80 Analog HART I/O											
BMEAH0412 (C)		X80 Analog HART I/O											
BMXDAI0805		X80 Discrete I/O											
BMXDAI0814		X80 Discrete I/O											
BMXDAI1602 (H)		X80 Discrete I/O											
BMXDAI1603 (H)		X80 Discrete I/O											
BMXDAI1604 (H)		X80 Discrete I/O											
BMXDAI1614 (H)		X80 Discrete I/O											
BMXDAI16142		X80 Discrete I/O											
BMXDAI1615 (H)		X80 Discrete I/O											
BMXDAO1605 (H)		X80 Discrete I/O											
BMXDAO1615 (H)		X80 Discrete I/O											
BMXDDI1602 (H)		X80 Discrete I/O											
BMXDDI1603 (H)		X80 Discrete I/O											
BMXDDI1604T		X80 Discrete I/O											
BMXDDI3202K (H)		X80 Discrete I/O											
BMXDDI3203 (H)		X80 Discrete I/O											
BMXDDI3232 (H)		X80 Discrete I/O											
BMXDDI6402K (H)		X80 Discrete I/O											
BMXDDM16022 (H)		X80 Discrete I/O											
BMXDDM16025 (H)		X80 Discrete I/O											
BMXDDM3202K		X80 Discrete I/O											
BMXDDO1602 (H)		X80 Discrete I/O											
BMXDDO1612 (H)		X80 Discrete I/O											
BMXDDO3202K (C)		X80 Discrete I/O											
BMXDDO6402K (C)		X80 Discrete I/O											
BMXDRA0804T		X80 Discrete I/O											
BMXDRA0805 (H)		X80 Discrete I/O											
BMXDRA0815 (H)		X80 Discrete I/O											
BMXDRA1605 (H)		X80 Discrete I/O											
BMXDRC0805 (H)		X80 Discrete I/O											

(1) Optional versions: (C) - "Coated", (H) - "Hardened", and (T) - "Extended Temperature"  
 (2) BMXXBP●●●● with PV02 or later required  
 (3) Extended rack can be any type of rack, but only X-bus modules (BMX) can be used

(4) Extended rack kit  
 (5) Not compatible with single power supplies  
 (6) Protective cover for all X-bus or Eth bus connectors

Compatible Not compatible

# Modicon M580/M340/X80 platforms

Product compatibility according to network architecture and platform

For safety product compatibility, please refer to [page 5/4](#)

Product type	Commercial reference (1)	Module type	M340		M580						M580 + M340		
					Local rack with CPU				X80 drops on Ethernet remote I/O				X80 drops on distributed I/O
			Standalone		Redundant		Standalone or redundant X-bus rack BMXXBP●●●●		Standalone X-bus + Ethernet rack BMEXP●●●●		Redundant X-bus + Ethernet rack BMEXP●●●●		X-bus rack BMXXBP●●●●
			X-bus rack (2) BMXXBP●●●●	X-bus + Ethernet rack BMEXP●●●●	X-bus rack (2) BMXXBP●●●●	X-bus + Ethernet rack BMEXP●●●●	BMXCRA31200	BMXCRA31210	BMECRA31210		BMXPRA0100		
Expert modules	BMXEAE0300 (H)	X80 SSI encoder interface module											
	BMXEHC0200 (H)	X80 Counter module											
	BMXEHC0800 (H)	X80 Counter module											
	BMXERT1604T/H	X80 Time-stamping module											
	BMXMSP0200	X80 Motion control module											
	BMXETM0200H	X80 Frequency input module											
Communication modules (4)	PMESWT0100	X80 Weighing module (3)											
	BMXNOM0200 (H)	X80 Serial link module											
	BMXEIA0100	X80 AS-Interface module											
	BMECXM0100 (H)	X80 CANopen master module											
	BMXNRP0200 (C)	X80 Fiber converter module											
	BMXNRP0201 (C)	X80 Fiber converter module											
	PMEPXM0100 (H)	X80 PROFIBUS DP Master module											
	BMENOS0300 (C)	X80 Ethernet switch module											
	BMENOC0301 (C)	M580 Ethernet module											
	BMENOC0311 (C)	M580 Ethernet FactoryCast module											
	BMENOC0321 (C)	M580 Ethernet control router											
	BMENOP0300	M580 IEC 61850 module											
	BMXNGD0100	M580 Ethernet Global Data module											
	BMENUA0100 (H)	M580 OPC UA module											
	BMXNOR0200H	M580/M340 RTU module											
	BMENOR2200H	M580 Advanced RTU module											
	BMXNOE0100 (H)	M340 Ethernet module											
	BMXNOE0110 (H)	M340 Ethernet FactoryCast module											
BMXNOC0401	M340 Ethernet module												
I/O expansion modules	BMXCRA31200	X80 Remote I/O drop adapter											
	BMXCRA31210 (C)	X80 Remote I/O drop adapter											
	BMECRA31210 (C)	X80 Remote I/O drop adapter											
	BMXPRA0100	X80 Peripheral remote I/O adapter											

(1) Optional versions: (C) - "Coated", (H) - "Hardened", and (T) - "Extended Temperature"  
 (2) BMXXBP●●●● with PV02 or later required  
 (3) Products by our Technology Partners; see more information on [our partner website page](#)  
 (4) According to the module type, communication modules description is included within X80 catalog, M580 catalog, or M340 catalog.

Compatible Not compatible





---

## Single-rack configuration

- Presentation, description, references ..... [page 2/2](#)
- Accessories for single-rack configuration ..... [page 2/5](#)

## Multi-rack configuration

- Presentation, description ..... [page 2/6](#)
- Accessories, references ..... [page 2/9](#)

#### Presentation

The Modicon X80 module platform is compatible with two types of backplanes:

- Dual Ethernet and X-bus backplanes
- X-bus backplanes (1).

One Ethernet switch is embedded inside the backplane with connectivity to some slots on the backplane, and not all slots have Ethernet connectivity.

X-bus functionality is preserved and conforms to the legacy implementation and specification. The X-bus will be used in a subset of modules on the Ethernet backplane.

The backplanes provide the power supply for the modules in the rack.

**BMXXBP●●00** racks are basic elements in Modicon X80 module platform single-rack and multi-rack configurations. They assign a rack number to X-bus slots. They also perform the following functions:

- Mechanical function: They are used to install modules in a PLC station (power supply, processor, discrete, analog, and application-specific I/O). These racks can be mounted on a panel or a plate:
  - Inside enclosures
  - On machine frames, etc.
- Electrical function: The racks incorporate X-bus (proprietary bus). They are used to:
  - Distribute the power supplies required for each module in the same rack
  - Distribute data and service signals for the entire PLC station
  - Hot swap modules during operation

**BMEXBP●●00** racks provide the following services to X-bus slots:

- Supply a rack number
- Supply the interconnection for the slots in the main and extended backplanes

**BMEXBP●●02** are dual power supply racks with two CPS slots for two redundant power supplies. They feature:

- Compatibility only with redundant power supplies
- Security of power supply in high-availability applications

The Ethernet interface is the main communication medium in the Ethernet backplane. The Ethernet modules on the Ethernet backplane are attached to one of several ports. The modules connect to the Ethernet switch chip embedded in the Ethernet backplane.

The Ethernet backplane provides the following services to ETH slots:

- ETH connection to ETH slots
- Point-to-point connection

#### Description

##### X-bus backplanes

**BMXXBP●●00** racks are available in 4, 6, 8, or 12-slot versions and comprise:

- 1 A metal frame with the following functions:
  - Holds the X-bus electronic card and helps it withstand EMI and ESD type interference
  - Holds the modules
  - Gives the rack mechanical rigidity
- 2 A ground terminal for grounding the rack
- 3 4 holes (big enough for M6 screws) for mounting the rack on a frame
- 4 2 fixing points for the shielding connection bar
- 5 Tapped holes to take the locking screw on each module
- 6 A connector for a rack expansion module, marked **XBE**
- 7 40-way female ½ DIN connectors forming the electrical connection between the rack and each module, marked **CPS, 00...11** (the rack is delivered with each connector protected by a cover, which needs to be removed before inserting the module)
- 8 Slots for anchoring the module pins

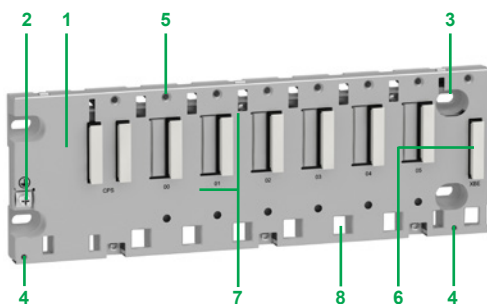

BMXXBP0600 rack with 6 slots

(1) Mandatory PV02 version or later.

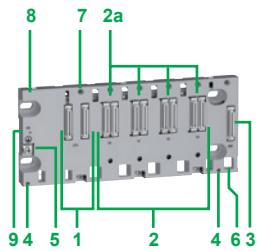

BMEXBP0400 backplane

#### Description (continued)

##### Dual Ethernet and X-bus backplanes

The number of X-bus and Ethernet slots found on a backplane depends on the backplane size.

**BMEXBP0400/BMEXBP0800** are 4/8-slot dual Ethernet and X-bus backplanes with:

- 1 CPS slot for power supply
- 2 4 slots (**BMEXBP0400**)/8 slots (**BMEXBP0800**) with:
- 2a 4/8 Ethernet and X-bus connectors for mixed modules
- 3 Extension: 1 connector for a X-bus backplane expansion
- 4 2 fixing points for the shielding connection bar
- 5 Protective ground screw
- 6 Slots for anchoring the module pin
- 7 Tapped holes for the locking screw on each module
- 8 4 holes for M4, M5, M6, or UNC #6-32 screws (4.32 mm to 6.35 mm/0.17 to 0.25 in.)
- 9 Rack fastened to 35 mm/1.38 in. wide and 15 mm/0.59 in. deep DIN rails. Mounting on a 35 mm/1.38 in. wide and 7.5 mm/0.295 in. deep DIN rail is also possible (in this case, the product withstands less mechanical stress).

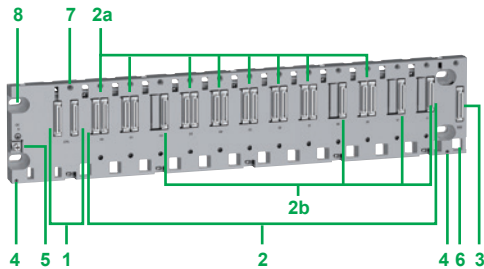

BMEXBP1200 backplane

**BMEXBP1200** is a 12-slot dual Ethernet and X-bus backplane with:

- 1 CPS slot for power supply
- 2 12 slots with:
- 2a 8 Ethernet and X-bus connectors for mixed modules
- 2b 4 X-bus connectors for X-bus modules
- 3 Extension: 1 connector for an X-bus backplane expansion
- 4 2 fixing points for the shielding connection bar
- 5 Protective ground screw
- 6 Slots for anchoring the module pin
- 7 Tapped holes for the locking screw on each module
- 8 4 holes for M4, M5, M6, or UNC #6-32 screws (4.32 mm to 6.35 mm/0.17 to 0.25 in.)

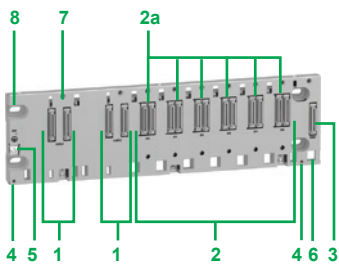

BMEXBP0602 backplane

##### Dual power supply backplanes

**BMEXBP0602** is a 6-slot dual Ethernet and X-bus backplane with:

- 1 2 CPS slots for **BMXCPS4002** redundant power supply only
- 2 6 slots with:
- 2a 6 Ethernet and X-bus connectors for mixed modules
- 3 Extension: 1 connector for an X-bus backplane expansion
- 4 2 fixing points for the shielding connection bar
- 5 Protective ground screw
- 6 Slots for anchoring the module pin
- 7 Tapped holes for the locking screw on each module
- 8 4 holes for M4, M5, M6, or UNC #6-32 screws (4.32 to 6.35 mm/0.17 to 0.25 in.)
- 9 Rack is fastened to 35 mm/1.38 in. wide and 15 mm/0.59 in. deep DIN rails. Mounting on a 35 mm/1.38 in. wide and 7.5 mm/0.295 in. deep DIN rail is also possible (in this case, the product withstands less mechanical stress).

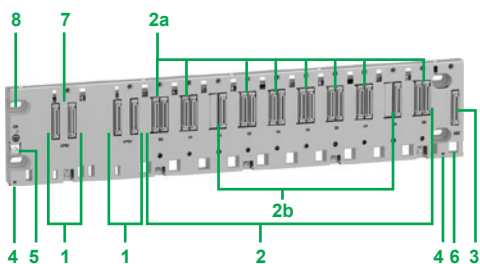

BMEXBP1002 backplane

**BMEXBP1002** is a 10-slot dual Ethernet and X-bus backplane with:

- 1 2 CPS slots for **BMXCPS4002** redundant power supply only
- 2 10 slots with:
- 2a 8 Ethernet and X-bus connectors for mixed modules
- 2b 2 X-bus connectors for X-bus modules
- 3 Extension: 1 connector for an X-bus backplane expansion
- 4 2 fixing points for the shielding connection bar
- 5 Protective ground screw
- 6 Slots for anchoring the module pin
- 7 Tapped holes for the locking screw on each module
- 8 4 holes for M4, M5, M6, or UNC #6-32 screws (4.32 to 6.35 mm/0.17 to 0.25 in.)

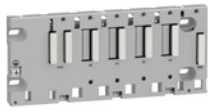

BMXXBP0400

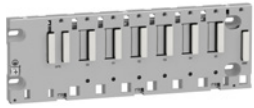

BMXXBP0600

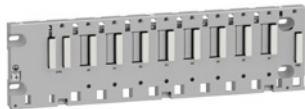

BMXXBP0800

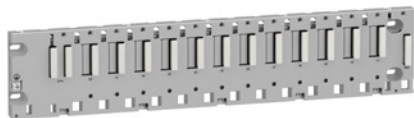

BMXXBP1200

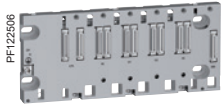

BMEXBP0400

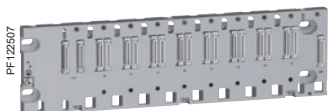

BMEXBP0800

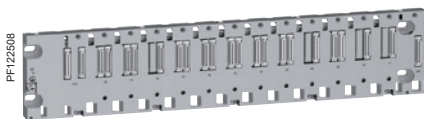

BMEXBP1200

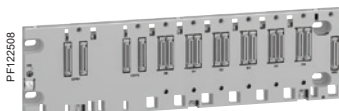

BMEXBP0602

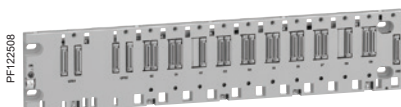

BMEXBP1002

#### X-bus racks

Description	Type of module to be inserted	No. of slots (1)	Power consumption (2)	Reference	Weight kg/lb
X-bus racks	BMXCPS power supply, <b>BMXP34</b> or <b>BMEP58</b> processor, I/O modules, communication modules and application-specific modules (counter, motion control, and serial)	4	1 W	<b>BMXXBP0400</b>	0.630/ 1.389
		6	1.5 W	<b>BMXXBP0600</b>	0.790/ 1.742
		8	2 W	<b>BMXXBP0800</b>	0.950/ 2.094
		12	–	<b>BMXXBP1200</b>	1.270/ 2.780

#### Ethernet + X-bus racks (3) (4)

Description (5)	Type of module to be inserted	Ethernet connectors	X-bus connectors	Power consumption (6)	Reference (3)	Weight kg/lb
4-slot Ethernet + X-bus backplane	BMXCPS power supply, <b>BMEP58/BMEH58</b> processor, I/O modules, communication modules and application-specific modules (counter, motion control, and serial)	4	4	2.8 W	<b>BMEXBP0400</b>	0.719/ 1.500
8-slot Ethernet + X-bus backplane	BMXCPS power supply, <b>BMEP58/BMEH58</b> processor, I/O modules, communication modules and application-specific modules (counter, motion control, and serial)	8	8	3.9 W	<b>BMEXBP0800</b>	1.064/ 2.350
12-slot (8 Ethernet + X-bus/4 X-bus) backplane	BMXCPS power supply, <b>BMEP58/BMEH58</b> processor, I/O modules, communication modules and application-specific modules (counter, motion control, and serial)	8	12	3.9 W	<b>BMEXBP1200</b>	1.398/ 3.080
6-slot Ethernet + X-bus dual power supply backplane	BMXCPS4002 redundant power supply, <b>BMEP58/BMEH58</b> processor, I/O modules, communication modules and application-specific modules (counter, motion control, and serial)	6	6	3.9 W	<b>BMEXBP0602</b>	1.377/ 3.036
10-slot (8 Ethernet + X-bus/2 X-bus) dual power supply backplane	BMXCPS4002 redundant power supply, <b>BMEP58/BMEH58</b> processor, I/O modules, communication modules and application-specific modules (counter, motion control, and serial)	8	10	3.9 W	<b>BMEXBP1002</b>	1.377/ 3.036

(1) Number of slots taking the processor module, I/O modules, communication modules, and application-specific modules (excluding power supply module).

(2) Power consumption of anti-condensation resistor(s).

(3) In an M580 architecture, Ethernet backplanes can be used for RIO drop Ethernet (EIO) but not as expansion racks anywhere. For expansion racks, it is necessary to use BMXXBP0400/0600/0800/1200 racks.

(4) For multi-rack configuration, see page 2/6.

(5) Number of slots for maximum number of modules excluding power supply rack expansion modules.

(6) Power consumption of anti-condensation resistor(s).

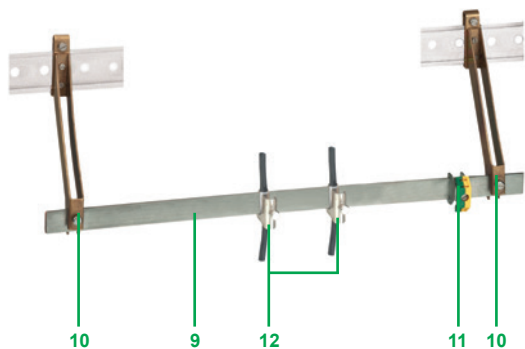

BMXXSP cable shielding connection kit

### Description

#### Dual Ethernet and X-bus backplanes

#### To be ordered separately:

A **BMXXSP** cable shielding connection kit, used to help protect against electrostatic discharge when connecting the shielding on cordsets for connecting:

- Analog, counter, and motion control modules
- A Magelis XBT operator interface to the processor (via **BMXXCAUSBH** shielded USB cable)

The **BMXXSP** shielding system comprises:

- 9 A metal bar that takes the clamping rings and the grounding terminal
- 10 Two sub-bases to be mounted on the rack
- 11 A grounding terminal (not included)
- 12 Not included in the shielding connection kit, the **STBXSP30** clamping rings (sold in lots of 10, cross-section 1.5...6 mm<sup>2</sup>/16...10 AWG or 5...11 mm<sup>2</sup>/10...7 AWG)



STBXSP3000 + STBXSP30

### Accessories

Description	For use with	Reference	Weight kg/lb
<b>Shielding connection kits</b> comprising: - 1 metal bar - 2 support sub-bases	BMXBP0400 rack	<a href="#">BMXXSP0400</a>	0.280/ 0.617
	BMXXBP0600 rack	<a href="#">BMXXSP0600</a>	0.310/ 0.683
	BMXBP0800 rack	<a href="#">BMXXSP0800</a>	0.340/ 0.750
	BMXBP1200 rack	<a href="#">BMXXSP1200</a>	0.400/ 0.882
	BMEXP1002 rack		
<b>Spring clamping rings</b> Sold in lots of 10	Cables, cross-section 1.5...6 mm <sup>2</sup> /16...10 AWG	<a href="#">STBXSP3010</a>	0.050/ 0.110
	Cables, cross-section 5...11 mm <sup>2</sup> /10...7 AWG	<a href="#">STBXSP3020</a>	0.070/ 0.154
<b>Protective covers</b> (replacement parts) Sold in lots of 5	Unoccupied slots on BMXBP cable rack	<a href="#">BMXXEM010</a>	0.005/ 0.011

(1) The grounding terminal is not included in the shielding connection kits.

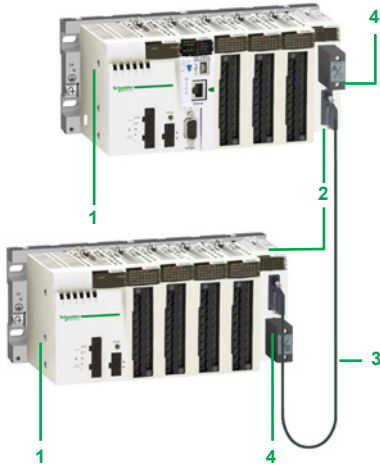

Modicon M340 + expansion rack



Modicon M580 + expansion rack

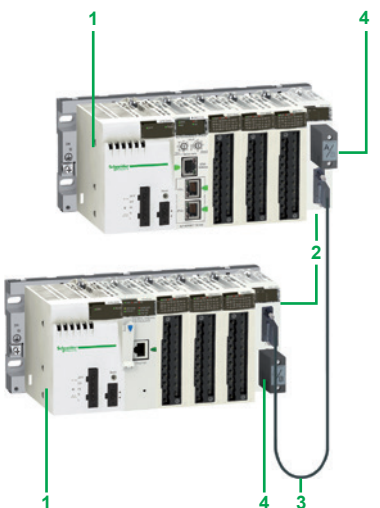

Modicon X80 drop + expansion rack

### Composition of a multi-rack configuration

Multi-rack configurations are made up of **BM●XBP●●00** racks (1). They comprise:

- 2 racks maximum for a station with a **BMXP341000** processor
- 4 racks maximum for a station with a **BMXP3420●●●** or **BMXP3420●●●CL** processor
- 4 racks maximum for a station with a **BMEP581020** or **BMEP5820●0** processor
- 8 racks maximum for a station with a **BMEP5830●0**, **BMEP5840●0**, **BMEP585040**, or **BMEP586040** processor

Each rack is equipped with:

- 1 A **BMXCPS●●●●●** power supply or two **BMXCPS4002** redundant power supplies (2)
- 2 A **BMXXBE1000** rack expansion module. This module, inserted in the right-hand end of the rack (**XBE** slot, see page 2/2) does not occupy rack slots **00...11** (4, 6, 8, or 12 slots are still available).
- 3 The **BMXXBE1000** rack expansion modules, which are connected to each other by X-bus cordsets

### X-bus

The racks, distributed on the X-bus, are connected to each other by X-bus extension cordsets **3** with a maximum total length of 30 m/98.42 ft.

The racks are connected in a daisy chain using **BMXXBC●●0K** (3) X-bus extension cordsets connected to the two 9-way SUB-D connectors **7** and **8** on the front panels of the **BMXXBE1000** rack expansion modules **2**.

### Line terminators 4

Both expansion modules at the ends of the daisy chain must have a line terminator **4 TSXTLYEX** on the unused 9-way SUB-D connector.

*Note: The processor module is always positioned in the rack at address 0. However, in an X-bus daisy chain, the order of the racks has no effect on operation. For example, the order of the daisy chain can be 0-1-2-3, 2-0-3-1, or 3-1-2-0, etc.*

### Composition of an expanded backplane configuration

The Modicon M580 standalone processor supports 4 to 8 local racks (depending on the CPU performance level), using existing X80 I/O modules and accessories. The Modicon M580 CPU can be installed in the first rack (0) which can be a dual bus rack. The M580 PLC will support up to 7 **BMXXBP●●●●●** PV02 or later backplanes (racks) of 4, 6, 8, or 12 slots. The main backplane (rack 0) will support the CPU.

To extend the configuration using additional racks, users can use a bus extender module (**BMXXBE1000**) and X-bus cables. The backplane extender should be plugged into the dedicated connector on the right side of the backplane. It does not occupy any module slot. The XBE extender module is not hot-swappable, like the rest of the X80 module platform. Each backplane has to include a power supply module and will support up to 12 modules.

An expansion rack can be connected to the main backplane and the X80 drop (EIO). The rack address is assigned as follows:

- Each rack will be assigned a physical address using 4 microswitches located in the bus extender module.
- The main rack containing the CPU will be assigned address 0.
- The other racks will be assigned addresses 1 to 7.

Each rack is equipped with:

- 1 A **BMXCPS●●●●●** power supply or two **BMXCPS4002** redundant power supplies (2)
- 2 A **BMXXBE1000** rack expansion module. This module, inserted in the right-hand end of the rack (**XBE** slot) does not occupy rack slots **00...11** (4, 6, 8, or 12 slots are still available).
- 3 The **BMXXBE1000** rack expansion modules, which are connected to each other by X-bus cordsets
- 4 Line terminators: Both expansion modules at the ends of the daisy chain must have a line terminator **4 TSXTLYEX** on the unused 9-way SUB-D connector.

(1) **BMEXBP●●●●●** is only supported on M580 processor based platforms.

(2) **BMXCPS4002** redundant power supply is only compatible only with the **BMEXBP0602** and **BMEXBP1002** dual power supply backplane.

(3) **BMXXBC●●0K** extension cordsets, length 0.8 m/2.62 ft, 1.5 m/4.92 ft, 3 m/9.84 ft, 5 m/16.4 ft, or 12 m/39.4 ft, with angled connectors or **TSXCBY●08K** extension cordsets, length 1 m/3.28 ft, 3 m/9.84 ft, 5 m/16.4 ft, 12 m/39.4 ft, 18 m/59 ft, or 28 m/92 ft, with straight connectors.

#### Ethernet racks

Modicon M580 CPUs support dual bus backplanes (Ethernet and X-bus), as well as Ethernet ring or star architectures on their Ethernet port.

- **BME●58●●2●** CPUs support Ethernet star or ring architectures (RSTP loop is supported on ports 2 and 3). The embedded scanner allows scanning of distributed equipment. The CPU directly drives these devices (“NOC” embedded function).
- **BME●58●●4●** CPUs support an embedded scanner that allows scanning of X80 drops on Ethernet RIO (EIO) and distributed equipment.

Modicon M580 CPUs have an additional third Ethernet port dedicated to the connection of a service tool such as a PC, HMI, or network analyzer. This port is labeled “ETH 1”. It does not support RSTP.

Modicon M580 CPUs can communicate on the main Ethernet backplane. They cannot be installed in an expansion rack.

It is necessary to use an Ethernet backplane:

Reference	Description
<b>BMEXBP0400</b>	Standard 4-slot backplane
<b>BMEXBP0800</b>	Standard 8-slot backplane
<b>BMEXBP1200</b>	Standard 12-slot backplane
<b>BMEXBP0602</b>	Dual power supply 6-slot backplane
<b>BMEXBP1002</b>	Dual power supply 10-slot backplane
<b>BMEXBP0400H</b>	Ruggedized 4-slot backplane
<b>BMEXBP0800H</b>	Ruggedized 8-slot backplane
<b>BMEXBP1200H</b>	Ruggedized 12-slot backplane
<b>BMEXBP0602H</b>	Ruggedized dual power supply 6-slot backplane
<b>BMEXBP1002H</b>	Ruggedized dual power supply 10-slot backplane

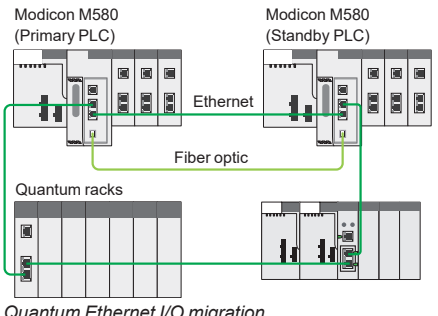

Quantum Ethernet I/O migration

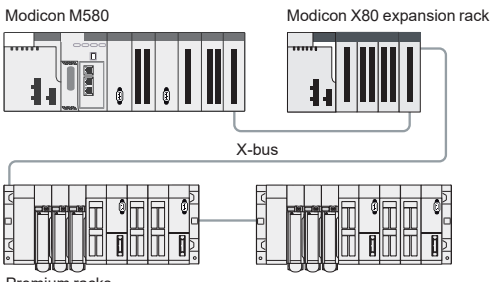

Premium X-bus expansion example



DIA6ED2151012EN

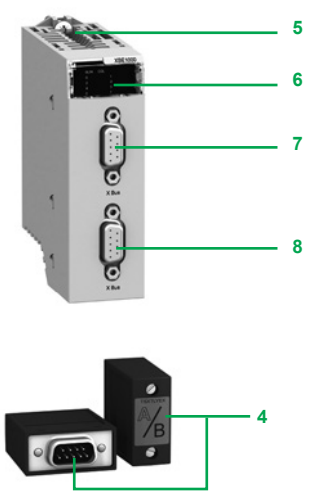

### Quantum Ethernet I/O migration

Modicon M580 CPUs levels 4 and above (**BMEP584040**, **BMEP585040**, and **BMEP586040**) support Quantum I/O using the Quantum Ethernet remote drop adapter **140CRA31200**. The number of Remote I/O drops allowed (up to 31) depends on the M580 processor model.

The Quantum Ethernet drop is configured using EcoStruxure Control Expert (1) software. Each Quantum I/O can be configured with the X80 I/O model (Device DDT) or the Quantum model ("State ram" :%I, %IW, %M, %MW) to simplify the reuse of legacy applications.

The compatibilities of Quantum I/O in an Ethernet Quantum drop are identical in a Quantum processor based architecture. See page 1/8 for more information.

In addition, the Modicon LL984 legacy language is supported by some CPU models; please refer to the M580 product catalog for more information.

### Premium X-bus extension

The Modicon M580 CPU supports revamping of an existing Premium installation by replacing the Premium rack 0 (CPU and communication modules) with an M580 rack. It is also possible to combine Premium racks **TSXRKY4EX/6EX/8EX/12EX** with X80 I/O based on an X-bus rack. The majority of existing configurations are supported. The number of expanded racks allowed depends on which CPU is being used:

- The **BMEP581020**, **BMEP582020**, and **BMEP582040** CPUs support a main local rack and up to 3 expansion racks. If you are using 4, 6, or 8-slot Premium expansion racks, you can install 2 physical racks at each assigned rack address, allowing up to 6 Premium expansion racks (up to 6 backplanes and 100 m/328 ft between 2 drops).
- The **BMEP583020**, **BMEP583040**, **BMEP584020**, and **BMEP584040** CPUs support a main local rack with up to 7 expansion racks. If you are using 4, 6, or 8-slot Premium expansion racks, you can install 2 physical racks at each assigned rack address, allowing up to 14 Premium expansion racks.

The maximum number of supported X-bus drops is as follows:

- 4 for **BMEP581000/2000**
- 8 for **BMEP583000/4000**

The maximum number of X-bus drops is calculated as follows:

- Max number = 1 for CPU rack (**BMXXBP0000** or **BMEXBP0000**)  
+ ½ the number of **TSXRKY4/6/8EX** racks + the number of **TSXRKY12EX** racks  
+ the number of **BMXXBP0000** racks

### Description

The front panel of the **BMXXBE1000** rack expansion module comprises:

- 5 A screw for locking the module in its slot (at the far right-hand end of the rack)
- 6 A display block with 5 LEDs:
  - RUN LED (green): Module running
  - COL LED (red): Several racks have the same address, or rack address 0 does not contain the **BMXP340000** or **BMXP580000** processor module
  - LEDs 0, 1, 2, and 3 (green): rack address 0, 1, 2, or 3
- 7 A 9-way female SUB-D connector, marked X-bus, for the incoming X-bus cordset **3** connected to the upstream rack, or if it is the first rack, for the **A/** line terminator included in the **TSXTLYEX 4** pack
- 8 A 9-way female SUB-D connector, marked X-bus, for the outgoing X-bus cordset **3** to the downstream rack, or if it is the last rack, for the **/B** line terminator included in the **TSXTLYEX 4** pack

#### On the right-hand side panel

A flap for accessing the 3 rack addressing microswitches: 0...3

#### Installation rules for **BM0XBP0000** racks

Rules for installing racks in enclosures (see our website [www.se.com](http://www.se.com)).

(1) EcoStruxure Control Expert software continues the Unity Pro range of software and corresponds to versions ≥ 14 of Unity Pro.





BMXXBE1000

#### Rack expansion

Description	Use	Reference	Weight kg/lb
<b>Modicon X80 I/O rack expansion module</b>	Standard module for mounting in each rack (XBE slot) and used to interconnect: - Up to 2 racks with BMXP341000 processor module - Up to 4 racks with BMXP342000 processor module - Up to 3 racks with BMEP581020/20000 processor module - Up to 7 racks with BMEP583000/4000/5000/6000 processor module - 1 rack with X80 drop (EIO)	<a href="#">BMXXBE1000</a>	0.178/ 0.392
<b>Modicon X80 I/O rack expansion kit</b>	Complete kit for 2-rack configuration comprising: - 2 BMXXBE1000 rack expansion modules - 1 BMXXBC008K extension cordset, length 0.8 m/2.62 ft - 1 TSXTLYEX line terminator (set of 2)	<a href="#">BMXXBE2005</a>	0.700/ 1.543



BMXXBC000K

#### Cordsets and connection accessories

Description	Use	Composition	Type of connector	Length m/ft	Reference	Weight kg/lb
<b>X-bus expansion cordsets</b> total length 30 m/98 ft max (1).	Between 2 BMXXBE1000 rack expansion modules	2 x 9-way SUB-D connectors	Angled	0.8/	<a href="#">BMXXBC008K</a>	0.165/
				2.62		0.363
				1.5/	<a href="#">BMXXBC015K</a>	0.250/
				4.92		0.551
				3/	<a href="#">BMXXBC030K</a>	0.420/
				9.84		0.926
				5/	<a href="#">BMXXBC050K</a>	0.650/
				16.4		1.433
				12/	<a href="#">BMXXBC120K</a>	1.440/
				39.4		3.175
Straight				1/	<a href="#">TSXCBY010K</a>	0.160/
				3.28		0.353
				3/	<a href="#">TSXCBY030K</a>	0.260/
				39.4		0.573
				5/	<a href="#">TSXCBY050K</a>	0.360/
				16.4		0.794
				12/	<a href="#">TSXCBY120K</a>	1.260/
				39.4		2.778
				18/	<a href="#">TSXCBY180K</a>	1.860/
				59		4.101
28/	<a href="#">TSXCBY280KT</a>	2.860/				
92	(2)(3)	6.305				

<b>Cable reel (1)</b>	Length of cable to be equipped with TSXCBYK9 connectors	Cable with ends with flying leads, 2 line testers	-	100/ 328	<a href="#">TSXCBY1000</a>	12.320/ 27.161
-----------------------	---	---	---	-------------	----------------------------	-------------------



TSXTLYEX

Description	Use	Composition	Sold in lots of	Reference	Weight kg/lb
<b>Line terminators</b>	Required on both BMXXBP0000 modules located at either end of the daisy chain	2 x 9-way SUB-D connectors marked A/ and /B	2	<a href="#">TSXTLYEX</a>	0.050/ 0.110
<b>X-bus straight connectors</b>	For TSXCBY1000 cables	2 x 9-way SUB-D straight connectors	2	<a href="#">TSXCBYK9</a>	0.080/ 0.176
<b>Connector assembly kit</b>	For fixing TSXCBYK9 connectors	2 crimping pliers, 1 pen (3)	-	<a href="#">TSXCBYACC10</a>	-

(1) Module and cordsets do not operate properly at temperatures lower than -25 °C/-13 °F.  
 (2) Cable supplied with a set of 2 TSXTVSY100 electrical transient suppressors.  
 (3) To fix the connectors to the cable, you also need a wire stripper, a pair of scissors, and a digital ohmmeter.



---

## X80 power supplies

- Presentation, description ..... [page 3/2](#)
- Functions, references ..... [page 3/3](#)

### Presentation

**BMXCPS●●●●** power supplies provide the power supply for each **BMEXBP●●00** or **BMXXBP●●00** Modicon X80 rack and the modules installed on it (**BMEXBP●●02** supports **BMXCPS●●●●2** modules only).

The Modicon X80 power supplies offer comprises:

- Five power supplies for DC line supplies:
  - 24 V  $\overline{\text{---}}$ , 17 W isolated power supply module, **BMXCPS2010**
  - 24...48 V  $\overline{\text{---}}$ , 32 W isolated power supply module, **BMXCPS3020**
  - 24...48 V  $\overline{\text{---}}$ , 40 W redundant power supply module, **BMXCPS4022**
  - 125 V  $\overline{\text{---}}$ , 36 W power supply module, **BMXCPS3540T** (extended operating temperature -25 to +70 °C/-13 to +158 °F)
  - 125 V  $\overline{\text{---}}$ , 40 W redundant power supply module, **BMXCPS3522**
- Three power supplies for AC line supplies:
  - 100...240 V  $\sim$ , 20 W power supply module, **BMXCPS2000**
  - 100...240 V  $\sim$ , 36 W power supply module, **BMXCPS3500**
  - 100...240 V  $\sim$ , 40 W redundant power supply module, **BMXCPS4002**

### Description

The power supply is selected according to:

- The electrical line supply: 24 V  $\overline{\text{---}}$ , 48 V  $\overline{\text{---}}$ , 125 V  $\overline{\text{---}}$ , or 100...240 V  $\sim$
- The required power (see the power consumption table available on our website [www.se.com](http://www.se.com)) (1)

**BMXCPS●●●●** power supplies have the following on the front panel:

- 1 A display block comprising:
  - OK LED (green), lit if rack voltages are present and correct
  - 24 V LED (green), lit when the sensor voltage is present (BMXCPS2000/3500/3540T power supply modules only)
  - RD LED (green), lit when all the internal power supply modules are functioning normally (BMXCPS4002/BMXCPS4022/BMXCPS3522 redundant power supply modules only)
  - ACT LED (green), lit when the power supply is the Master power supply, off when it acts as a slave supply in redundant application (BMXCPS4002/BMXCPS4022/BMXCPS3522 redundant power supply modules only)
- 2 A pencil-point RESET pushbutton for a cold restart of the application
- 3 A 2-way connector that can take a removable terminal block (caged or spring-type) for connecting the alarm relay
- 4 A 5-way connector that can take a removable terminal block (caged or spring-type) for connecting the following:
  - $\overline{\text{---}}$  or  $\sim$  line supply
  - Protective ground
  - Dedicated 24 V  $\overline{\text{---}}$  power supply for the input sensors (for BMXCPS2000/3500/3540T power supply modules only)

**Included with each power supply module:**

- Set of two **BMXXTSCPS10** caged removable terminal blocks (5-way and 2-way)

**To be ordered separately (if necessary):**

- Set of two **BMXXTSCPS20** spring-type removable terminal blocks (5-way and 2-way)

### Compatibility of the power supply with the rack

The redundant AC power supply can be used alone in a single power supply rack or as a pair in a dual power supply rack. For high-availability applications, two independent redundant power supplies can be used to increase the security of power supply. In case the master power supply fails to provide the total current, the slave power supply will change to master mode and continue to function.

Type	Standalone power supply (BMXCPS●●●0)	Redundant power supply (BMXCPS●●●2)
Single power supply racks (BMXXBP●●00, BMEXBP●●00)		
Dual power supply racks (BMEXBP●●02)		

  Compatible  
  Incompatible

(1) This power consumption calculation for the rack can also be performed by EcoStruxure Control Expert V14 (Unity Pro in earlier versions) programming software.

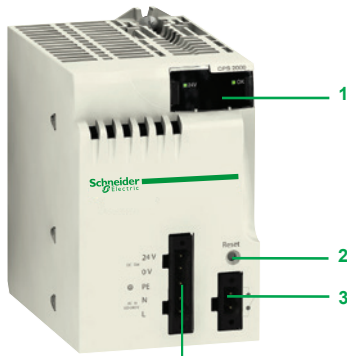

BMXCPS2000

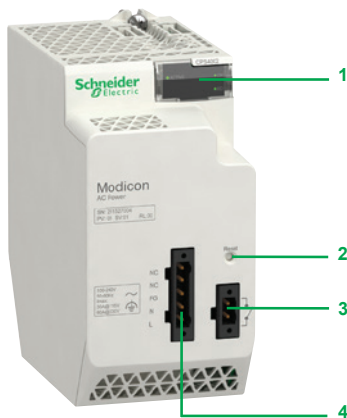

BMXCPS4002



BMXCPS2010/3020



BMXCPS2000/3500



BMXCPS4002



BMXCPS4022



BMXCPS3522

### Functions

#### Alarm relay

The alarm relay incorporated in each power supply module has a volt-free contact accessible on the front panel, on the 2-way connector.

The operating principle is as follows:

In normal operation, with the PLC in RUN, the alarm relay is energized and its contact is closed (state 1).

The relay de-energizes and its associated contact opens (state 0) whenever the application stops, even partially, due to any of the following:

- Detection of a blocking fault
- Incorrect rack output voltages
- Loss of supply voltage

#### RESET pushbutton

The power supply module in each rack has a RESET button on the front panel which, when pressed, triggers an initialization sequence on the processor and the modules in the rack it supplies.

Pressing this pushbutton triggers a sequence of service signals, which is the same as that for:

- A power break, when the pushbutton is pressed
- A power-up, when the pushbutton is released
- In terms of the application, these operations represent a cold start (forcing the I/O modules to state 0 and initializing the processor).

#### Sensor power supply

**BMXCPS2000/3500** AC power supplies and **BMXCPS3540T** DC power supplies have an integrated 24 V  $\bar{\text{---}}$  supply for powering the input sensors.

Connection to this 24 V  $\bar{\text{---}}$  sensor power supply is via the 5-way connector on the front panel. The available power depends on the power supply (0.45 A or 0.9 A).

### References

Each **BMEXBP●●00** or **BMXXBP●●00** rack must be equipped with a power supply. **BMEXBP●●02** must be equipped with 1 or 2 redundant power supplies. These power supplies are inserted in the leftmost power supply slots of each rack (marked CPS).

The power required to supply each rack depends on the type and number of modules installed in the rack. It is therefore necessary to draw up a power consumption table for each rack in order to determine which

**BMXCPS●●●●** power supply is the most suitable for each rack (please consult our website [www.se.com](http://www.se.com)).

#### X80 Power supplies (1)

Line supply	Available power (2)			Total	Nominal current 24 V $\bar{\text{---}}$ rack (3)	Reference	Weight kg/lb
	3.3 V $\bar{\text{---}}$ (3)	24 V $\bar{\text{---}}$ rack (3)	24 V $\bar{\text{---}}$ sensors (4)				
24 V $\bar{\text{---}}$ isolated	8.3 W	17 W	–	17 W	0.7 A	<a href="#">BMXCPS2010</a>	0.290/ 0.639
24...48 V $\bar{\text{---}}$ isolated	15 W	32 W	–	32 W	1.3 A	<a href="#">BMXCPS3020</a>	0.340/ 0.750
24...48 V $\bar{\text{---}}$	18 W	40 W	–	40 W	1.67 A	<a href="#">BMXCPS4022</a>	0.810/ 1.786
100...150 V $\bar{\text{---}}$	15 W	31.2 W	21.6 W	36 W (5)	1.3 A	<a href="#">BMXCPS3540T</a> (5)	0.340/ 0.750
	18 W	40 W	–	40 W	1.67 A	<a href="#">BMXCPS3522</a>	0.610/ 1.345
100...240 V $\sim$	8.3 W	16.8 W	10.8 W	20 W	0.7 A	<a href="#">BMXCPS2000</a>	0.300/ 0.661
	15 W	31.2 W	21.6 W	36 W	1.3 A	<a href="#">BMXCPS3500</a>	0.360/ 0.794
	18 W	40 W	–	40 W	1.67 A	<a href="#">BMXCPS4002</a>	0.360/ 0.794

#### Separate parts

Description	Type	Composition	Reference	Weight kg/lb
Set of 2 removable connectors	Spring-type	One 5-way terminal block and one 2-way terminal block	<a href="#">BMXXTSCPS20</a>	0.015/ 0.033
	Caged	One 5-way terminal block and one 2-way terminal block	<a href="#">BMXXTSCPS10</a>	0.020/ 0.044

(1) Include a set of 2 caged removable connectors. Spring-type connectors available separately under reference [BMXXTSCPS20](#).

(2) The sum of the power consumed on each voltage (3.3 V  $\bar{\text{---}}$  and 24 V  $\bar{\text{---}}$ ) must not exceed the total power of the module. See the power consumption table available on our website [www.se.com](http://www.se.com).

(3) 3.3 V  $\bar{\text{---}}$  and 24 V  $\bar{\text{---}}$  rack voltages for powering modules in the Modicon X80 I/O rack.

(4) 24 V  $\bar{\text{---}}$  sensor voltage for powering the input sensors (voltage available via the 2-way removable connector on the front panel).

(5) Extended operating temperature -25 to +70 °C/-13 to +158 °F (with power derating at extreme temperatures: 27 W between -25 and 0 °C/-13 and 0 °F and between 60 and 70 °C/140 and 158 °F).



---

## X80 Discrete I/O modules

- [Selection guide](#) ..... page 4/2
- [Presentation, description](#) ..... page 4/8
- [Functions](#) ..... page 4/9
- [Connection devices](#) ..... page 4/10
- [Complementary characteristics](#) ..... page 4/12
- [References](#) ..... page 4/13

## X80 Analog I/O modules

- [Selection guide](#) ..... page 4/16
- [Presentation](#) ..... page 4/20
- [Description](#) ..... page 4/21
- [Connections, combinations](#) ..... page 4/22
- [Complementary characteristics](#) ..... page 4/23
- [References](#) ..... page 4/25

## X80 HART analog I/O modules

- [Selection guide](#) ..... page 4/26
- [Presentation, description](#) ..... page 4/28
- [References](#) ..... page 4/29

# Modicon X80 module platform

X80 I/O modules  
Discrete input modules

Applications **8-channel discrete input modules** **16-channel discrete input modules**



<b>Type</b>	~		---			~ or ---		~				
<b>Voltage</b>	200...240 V	100...120 V	24 V	48 V	125 V	24 V (~ or ---)	48 V	100...120 V	200...240 V			
<b>Current per channel</b>	10.4 mA (for U = 220 V at 50 Hz)	5 mA	3.5 mA	2.5 mA	2.4 mA	3 mA (~) 3.9 mA (---)	5 mA	10.1 mA (max) at 50 Hz 11.9 mA (max) at 60 Hz		9.7 mA (max) at 50 Hz 11.5 mA (max) at 60 Hz		
<b>Modularity</b> (Number of channels and commons)	8 inputs and 1 common		8 isolated inputs		16 inputs and 1 common			16 isolated inputs				
<b>Connection</b>	Via <b>BMXFTB20•0</b> 20-way caged, screw clamp, or spring-type removable terminal block						Via <b>BMXFTB40•0</b> 40-way caged or spring-type removable terminal block					
<b>Inputs</b>	IEC/EN 61131-2 conformity		Type 2		Type 3	Type 1	Non-type	Type 1 (~) Non-type (---)	Type 3	Type 1	Non-type at 50 Hz Type 1 at 60 Hz	Type 1
Logic	-		Positive (sink)		-			Positive (sink) / Negative (source) (---)	-		-	
Type of input	Capacitive		Current sink		-			Resistive	Capacitive		-	
Sensor compatibility IEC/EN 60947-5-2	2-wire ~		2-wire ---, 3-wire --- PNP any type		-			2-wire ---/~, 3-wire --- PNP/NPN any type	2-wire ~		-	
<b>Sensor power supply</b> (ripple included)	170...264 V ~	85...132 V ~ (no sensor power monitoring)	19...30 V ---	38...60 V ---	88...150 V ~	20...26 V ~ 19...30 V ---	40...52 V ~	85...132 V ~	100...120 V ~	200...240 V ~		
<b>Protection of inputs</b>	Use one 0.5 A fast-blow fuse per group of channels	Use one 0.25 A fast-blow fuse per channel	Use one 0.5 A fast-blow fuse per group of channels									
<b>Maximum dissipated power</b>	4.73 W	2.35 W	2.5 W	3.6 W	8.5 W (at 40 °C/104 °F)	3 W	4 W	3.8 W	4.3 W			
<b>Operating temperature</b>	0...60 °C/32...140 °F					-25...70 °C/-13...158 °F		0...60 °C/32...140 °F				
<b>Dimension</b>	W x H x D		32 x 100 x 86 mm/1.25 x 3.93 x 3.38 in.						32 x 131 x 86 mm/1.25 x 5.15 x 3.38 in.			
<b>Compatibility with TeSys Quickfit installation system</b>	-											
<b>Compatibility with Modicon Telefast ABE7 pre-wired system (1)</b>	Passive connection sub-bases		-									
	Adapter sub-bases with relays		-									
<b>References</b>	<b>BMXDAI0805</b>	<b>BMXDAI0814</b>	<b>BMXDDI1602</b>	<b>BMXDDI1603</b>	<b>BMXDDI1604T</b>	<b>BMXDAI1602</b>	<b>BMXDAI1603</b>	<b>BMXDAI1604</b>	<b>BMXDAI1614</b>	<b>BMXDAI16142</b>	<b>BMXDAI1615</b>	
<b>Pages</b>	4/13											

(1) For more information, please refer to the "Telefast Pre-wired system – Modicon ABE7 IP20 connection sub-bases" catalog or visit our website [www.se.com](http://www.se.com).



# Modicon X80 module platform

X80 I/O modules  
Discrete input and mixed I/O modules

Applications	32-channel high-density discrete input module	32-channel discrete input modules		64-channel high-density discrete input module	16-channel discrete mixed I/O modules		32-channel high-density discrete mixed I/O module
--------------	---	-----------------------------------	--	---	---------------------------------------	--	---



Type	---			--- inputs and ---/~ relay outputs		---		
Voltage	24 V	12/24 V	48 V	24 V	Inputs: 24 V Solid-state outputs: 24 V	Inputs: 24 V --- Relay outputs: 24 V --- or 24...240 V ~	Inputs: 24 V Solid-state outputs: 24 V	
Current per channel	Inputs	2.5 mA	3.3 mA	2.3 mA	0.6 mA	3.5 mA	3.5 mA	
	Outputs	-	-	-	-	0.5 A	2 A (--- or ~)	
Modularity (Number of channels and commons)	32 inputs and 2 commons			64 inputs and 4 commons		8 inputs and 1 common, 8 outputs and 1 common		
Connection	Via one 40-way connector with preassembled cordsets		Via <b>BMXFTB4000</b> 40-way caged or spring-type removable terminal block		Via two 40-way connectors with preassembled cordsets		Via <b>BMXFTB2000</b> 20-way caged, screw clamp, or spring-type removable terminal block	
Inputs	IEC/EN 61131-2 conformity	Type 1		Type 3	Non-type	Type 3		
	Logic	Positive (sink)		Positive (sink) / Negative (source)	Positive (sink)			
Type of input	Current sink	Current sink		Current sink/source	Current sink			
	Sensor compatibility IEC/EN 60947-5-2	2-wire ---, 3-wire --- PNP any type		2-wire ---, 3-wire --- PNP/NPN any type	2-wire ---, 3-wire --- PNP any type	2-wire ---, 3-wire --- PNP any type		
Sensor power supply (ripple included)	19...30 V ---		10.8...30 V ---	38...60 V ---	19...30 V ---			
Protection of inputs	Use one 0.5 A fast-blow fuse per group of channels							
Outputs	Fallback	-				Configurable output fallback, continuous monitoring of output control, and resetting of outputs in case of internal detected fault		
	IEC/EN 61131-2 conformity	-				Yes		
Protection	Logic	-				Protected	Not protected	Protected
	Logic	-				Positive	-	Positive
Preactuator power supply (ripple included)	19...30 V ---		19...30 V ---		19...30 V ---	19...30 V --- 24...240 V ~	19...30 V ---	
Output fuse protection	-		-		Use one 6.3 A fast-blow fuse per group of channels	Use one 12 A fast-blow fuse per group of channels	Use one 2 A fast-blow fuse per group of channels	
Maximum dissipated power	3.9 W	4.7 W	6 W	4.3 W	3.7 W	3.1 W	4 W	
Operating temperature	0...60 °C/32...140 °F							
Dimension	W x H x D		32 x 100 x 86 mm/1.25 x 3.93 x 3.38 in.		32 x 131 x 86 mm/1.25 x 5.15 x 3.38 in.		32 x 100 x 86 mm/1.25 x 3.93 x 3.38 in.	
Compatibility with TeSys Quickfit installation system	LU9G02 splitter boxes (8 motor starters) and <b>BMXFCC001/003</b> preassembled cordsets (see pages 4/9 and 4/13)		-		LU9G02 splitter boxes (8 motor starters) and <b>BMXFCC001/003</b> preassembled cordsets (see pages 4/9 and 4/13)		LU9G02 splitter boxes (8 motor starters) and <b>BMXFCC001/003</b> preassembled cordsets (see pages 4/9 and 4/13)	
Compatibility with Modicon Telefast ABE7 pre-wired system (1)	Passive connection sub-bases	Depending on model (2)		-		-		
	Adapter sub-bases with relays	Depending on model (3)		-		Depending on model (3)		
References	<b>BMXDDI3202K</b>	<b>BMXDDI3232</b>	<b>BMXDDI3203</b>	<b>BMXDDI6402K</b>	<b>BMXDDM16022</b>	<b>BMXDDM16025</b>	<b>BMXDDM3202K</b>	
Pages	4/13					4/14		

(1) For more information, please refer to the "Telefast Pre-wired system - Modicon ABE7 IP20 connection sub-bases" catalog or visit our website [www.se.com](http://www.se.com).  
 (2) 8- or 16-channel passive sub-bases, with or without LED, with common or 2 terminals per channel  
 (3) Active sub-bases with solid state or electromagnetic relays (fixed or removable), 16 channels, with common or 2 terminals per channel (caged or spring-type connection)

# Modicon X80 module platform

## X80 I/O modules Discrete output modules

Applications	16-channel discrete output modules				32-channel high-density discrete output module	64-channel high-density output module	8-channel relay output modules			16-channel relay output module
--------------	------------------------------------	--	--	--	--	---------------------------------------	--------------------------------	--	--	--------------------------------



Type	☐ transistor				~ triac	☐ transistor		☐ relay		☐/~ relay					
Voltage	24 V		100...240 V	24...240 V		24 V		100...150 V		24 V ☐ 24...240 V ~	24...125 V ☐ 24...240 V ~	24...125 V ☐ 24...240 V ~	24 V ☐ 24...240 V ~		
Current per channel	0.5 A		0.6 A	3 A		0.1 A		0.3 A (lth)		3 A (lth)	3 A (lth)	4 A (lth)	2 A (lth)		
Modularity (Number of channels and commons)	16 outputs and 1 common		16 outputs and 4 commons	16 isolated outputs		32 outputs and 2 commons		64 outputs and 4 commons		8 normally open isolated relay outputs		8 normally open isolated relay outputs	8 normally open and normally close isolated relay outputs	16 normally open relay outputs and 2 commons	
Connection	Via <b>BMXFTB20●0</b> 20-way caged, screw clamp, or spring-type removable terminal block			Via <b>BMXFTB40●0</b> 40-way caged or spring-type removable terminal block		Via one 40-way connector with preassembled cordsets		Via two 40-way connectors with preassembled cordsets		Via <b>BMXFTB20●0</b> 20-way caged, screw clamp, or spring-type removable terminal block			Via <b>BMXFTB40●0</b> 40-way caged or spring-type removable terminal block		Via <b>BMXFTB20●0</b> 20-way caged, screw clamp, or spring-type removable terminal block
Outputs	Fallback														
	Configurable output fallback, continuous monitoring of output control, and resetting of outputs in case of internal detected fault														
	Configurable output fallback														
	Configurable output fallback, continuous monitoring of output control, and resetting of outputs in case of internal detected fault														
	Configurable output fallback														
IEC/EN 61131-2 conformity	Yes														
Protection	Yes														
Logic	Positive (source)    Negative (sink)														
Preactuator power supply (ripple included)	19...30 V ☐		100...240 V ~	24...240 V ~		19...30 V ☐		100...150 V ☐		10...34 V ☐ 19...264 V ~	5...150 V ☐ 19...264 V ~	5...150 V ☐ 19...264 V ~	19...30 V ☐ 24...240 V ~		
Output fuse protection	Use one 6.3 A fast-blow fuse per group of channels		Use one 3 A fast-blow fuse per group of channels	Use one 4 A fast-blow fuse per channel		Use one 2 A fast-blow fuse per group of channels		Use one 0.5 A fast-blow fuse per each channel		Use one 3 A fast-blow fuse per each channel	Use one fast-blow fuse per each channel	Use one fast-blow fuse per each channel	Use one 12 A fast-blow fuse per each group of channels		
Maximum dissipated power	4 W		2.26 W	-		3.6 W		6.85 W		3.17 W	2.7 W	5.76 W	6.84 W	3 W	
Operating temperature	0...60 °C/32...140 °F														
Dimension	32 x 100 x 86 mm/1.25 x 3.93 x 3.38 in.			32 x 131 x 86 mm/ 1.25 x 5.15 x 3.38 in.		32 x 100 x 86 mm/1.25 x 3.93 x 3.38 in.					32 x 131 x 86 mm/ 1.25 x 5.15 x 3.38 in.		32 x 100 x 86 mm/ 1.25 x 3.93 x 3.38 in.		
Compatibility with TeSys Quickfit installation system	-														
Compatibility with Modicon Telefast ABE7 pre-wired system (1)	Passive connection sub-bases Adapter sub-bases with relays														
References	<b>BMXDDO1602</b>	<b>BMXDDO1612</b>	<b>BMXDAO1605</b>	<b>BMXDAO1615</b>	<b>BMXDDO3202K</b>	<b>BMXDDO6402K</b>	<b>BMXDRA0804T</b>	<b>BMXDRA0805</b>	<b>BMXDRA0815</b>	<b>BMXDRC0805</b>	<b>BMXDRA1605</b>				
Pages	4/14														

(1) For more information, please refer to the "Telefast Pre-wired system -- Modicon ABE7 IP20 connection sub-bases" catalog or visit our website [www.se.com](http://www.se.com).  
 (2) 8- or 16-channel passive sub-bases, with or without LED, with common or 2 terminals per channel  
 (3) Active sub-bases with solid state or electromagnetic relays (fixed or removable), 16 channels, with common or 2 terminals per channel (caged or spring-type connection)

4

#### Presentation

Discrete I/O modules in the Modicon X80 offer are standard modules occupying a single slot on the rack. These modules are equipped with one of the following:

- A connector for a 20-way caged, screw clamp, or spring-type removable terminal block
- A connector for a 40-way caged or spring-type removable terminal block
- One or two 40-way connectors

This wide range of discrete I/O can be used to meet whatever requirements arise in terms of:

- Functions: AC or DC I/O, positive or negative logic
- Modularity: 8, 16, 32, or 64 channels per module

The inputs receive signals from the sensors and perform the following functions:

- Acquisition
- Adaptation
- Electrical isolation
- Filtering
- Protection against interference signals

The outputs memorize commands issued by the processor to enable control of the preactuators via the decoupling and amplification circuits.

#### Description

**BMXD●/D●O/DR** discrete I/O modules are standard format (1 slot). They have an IP20 case to help protect the electronics, and are locked into position with a captive screw.

#### I/O modules connected via 20-way removable terminal block

- 1 Rigid body providing support and protection for the electronic card
- 2 Module reference marking (a label is also visible on the right-hand side of the module)
- 3 Channel status display block
- 4 Connector taking the 20-way removable terminal block for connection of sensors or preactuators

To be ordered separately:

- 5 **BMXFTB20●0** 20-way removable terminal block (identification label supplied with each I/O module) or a preassembled cordset with a 20-way removable terminal block at one end and flying leads at the other (see [page 4/15](#)).

#### I/O modules connected via 40-way removable terminal block

- 1 Rigid body providing support and protection for the electronic card
- 2 Module reference marking (a label is also visible on the right-hand side of the module)
- 3 Channel status display block
- 4 Connector taking the 40-way removable terminal block for connection of sensors or preactuators

To be ordered separately:

- 5 **BMXFTB40●0** 40-way removable terminal block (identification label supplied with each I/O module) or a preassembled cordset with a 40-way removable terminal block at one end and flying leads at the other (see [page 4/15](#))

#### I/O modules connected via 40-way connector(s)

- 1 Rigid body providing support and protection for the electronic card
- 2 Module reference marking (a label is also visible on the right-hand side of the module)
- 3 Channel status display block
- 4 One or two 40-way connectors (32 or 64 channels) (1) for connection of sensors or preactuators
- 5 With the 64-channel module, a pushbutton which, with successive presses, displays the state of channels 0...31 or 32...63 on the display block 3 (see [page 4/9](#))

To be ordered separately, depending on the type of module:

One or two preassembled cordset(s) with a 40-way connector (see [page 4/15](#))

(1) Fujitsu FCN 40-way connector

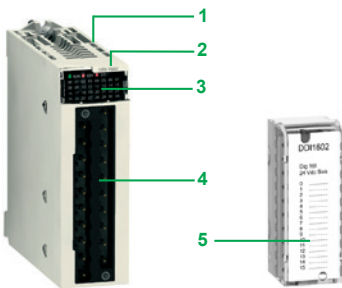

Module for connection via 20-way removable terminal block

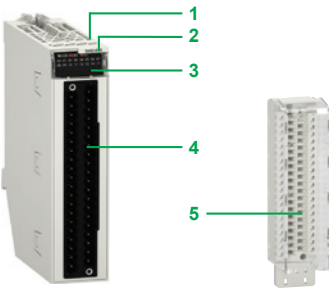

Module for connection via 40-way removable terminal block

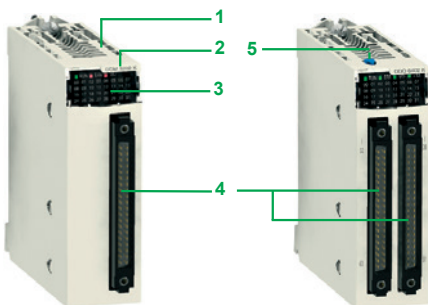

32- and 64-channel modules for connection via one or two 40-way connector(s)

#### Functions (1)

The discrete I/O modules provide the following functions:

- **Hot swapping:** Due to their special integrated devices, I/O modules (including application-specific modules) can be removed or added while the power is on.
- **I/O assignment:** The channels of discrete I/O modules are grouped into blocks of 4, 8, or 16 consecutive channels depending on the type of module. Each group of channels can be assigned to a specific application task, namely master or fast.
- **Protection of DC inputs:** The 24 V  $\overline{DC}$  and 48 V  $\overline{DC}$  inputs are constant-current type. This characteristic limits the current consumed at the inputs.
- **Protection of DC outputs:** Active transistor outputs can withstand overloads, short-circuits, reverse polarity, and inductive over-voltage.
- **Reactivation of DC outputs:** If a line fault has caused an output to trip, the output can be reactivated using this parameter if no other terminal line fault is present. Reactivation is controlled by means of a group of 8 channels. It can be programmed or automatic.
- **RUN/STOP command:** An input can be configured to control the RUN/STOP changeover for the PLC.
- **Output fallback:** This parameter defines the fallback mode used by the DC transistor outputs when the PLC stops. It can assume the "fallback" value at state 0 or state 1 for the corresponding group of 8 channels or the "maintain" value representing the state of the outputs before the PLC stops.
- **I/O module diagnostics:** Each discrete I/O module is equipped with a display block on the front panel centralizing the information necessary for module control, diagnostics, and maintenance.
  - **Diagnostics via EcoStruxure Control Expert (2):** Using the integrated diagnostics in EcoStruxure Control Expert (2), local diagnostics screens are available at global hardware configuration level, module level, and channel level.
  - **Remote diagnostics using a Web browser on a «Thin Client» PC:** In addition, the diagnostics described above can be performed remotely using a simple Web browser thanks to the standard Web server integrated in the Modicon X80 module platform (processor with integrated Ethernet port or Ethernet module), using the "ready-to-use" Rack Viewer function.
- **Compatibility with 2-wire and 3-wire sensors:** The discrete input modules can be used in conjunction with OsiSense XS inductive proximity sensors and with OsiSense XU photoelectric sensors (3).



Display block for module  
BMXDDO6402K

(1) For further information, please consult our website at [www.se.com](http://www.se.com).

(2) EcoStruxure Control Expert software continues the Unity Pro range of software and corresponds to versions  $\geq 14$  of Unity Pro.

(3) For further information, please consult Telemecanique Sensors website [www.tesensors.com](http://www.tesensors.com).



DIA3ED2160602EN

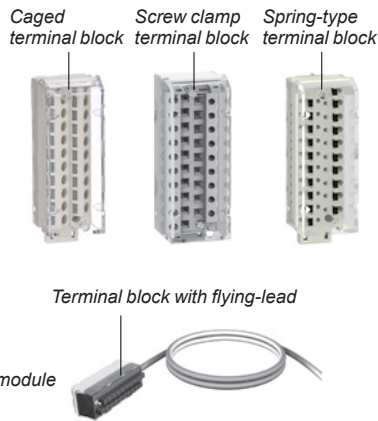

Example of I/O module with 20 pins

Accessories for connecting 20-pin modules

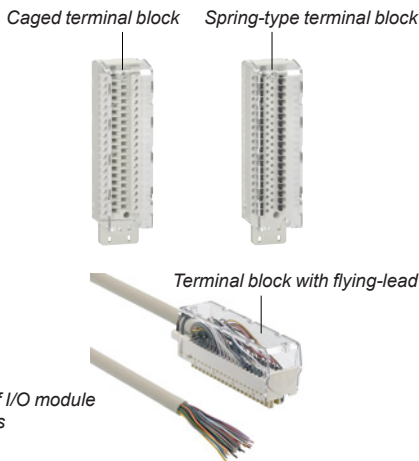

Example of I/O module with 40 pins

Accessories for connecting 40-pin modules

#### Connecting modules with 20-way removable terminal blocks

There are three types of 20-way removable terminal block:

- Screw clamp terminal block
- Caged terminal block
- Spring-type terminal block

Each removable terminal block can take:

- Bare wires
- Wires equipped with **DZ5CE/AZ5DE** cable ends

One version of the removable terminal block is equipped with 3, 5, or 10 m /4.92, 9.84, or 16.4 ft cordsets with color-coded flying leads (**BMXFTW●●1**).

#### Caged terminal blocks

The capacity of each terminal is:

- Minimum: One 0.34 mm<sup>2</sup> wire (AWG 22)
- Maximum: One 1 mm<sup>2</sup> wire (AWG 18)

**BMXFTB2000** caged connectors are equipped with captive screws (maximum tightening torque 0.5 N.m/0.37 lb-ft).

#### Screw clamp terminal blocks

The capacity of each terminal is:

- Minimum: One or two 0.34 mm<sup>2</sup> wires (AWG 22)
- Maximum: Two 1.5 mm<sup>2</sup> wires (AWG 16)

**BMXFTB2010** screw clamp connectors are equipped with captive screws (maximum tightening torque 0.5 N.m/0.37 lb-ft).

#### Spring terminal blocks

The capacity of each terminal in the **BMXFTB2020** spring-type terminal blocks is:

- Minimum: One 0.34 mm<sup>2</sup> wire (AWG 22)
- Maximum: One 1 mm<sup>2</sup> wire (AWG 18)

#### Connecting modules with 40-way removable terminal blocks

There are two types of 40-way removable terminal block:

- Caged terminal block
- Spring-type terminal block

Each removable terminal block can take:

- Bare wires
- Wires equipped with **DZ5CE/DZ5CA** cable ends

One version of the removable terminal block is equipped with 3 or 5 m /4.92 or 9.84 ft cordsets with color-coded flying leads (**BMXFTW●●5**).

#### Caged terminal blocks

The capacity of each terminal is:

- Minimum: One 0.34 mm<sup>2</sup> wire (AWG 22)
- Maximum: One 1 mm<sup>2</sup> wire (AWG 18)

**BMXFTB4000** caged connectors are equipped with captive screws (maximum tightening torque 0.4 N.m/0.30 lb-ft).

#### Spring terminal blocks

The capacity of each terminal in the **BMXFTB4020** spring-type terminal blocks is:

- Minimum: One 0.34 mm<sup>2</sup> wire (AWG 22)
- Maximum: One 1 mm<sup>2</sup> wire (AWG 18)

4

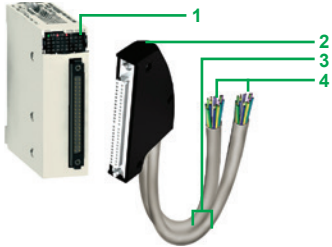

Preassembled cordset with 40-way connector and two ends with flying leads

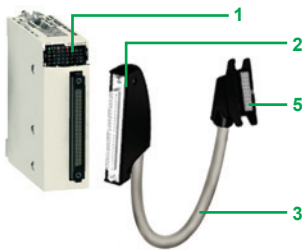

Preassembled cordset with 40-way connectors and HE10 connectors for Modicon Telefast ABE7 system

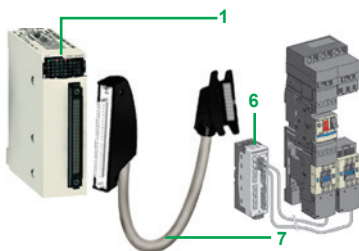

Example of connection to the TeSys Quickfit installation system

#### Connecting modules with 40-way connectors

##### Preassembled cordsets with 40-way connector at one end and flying leads at the other

Preassembled cordsets can be used for easy direct wire-to-wire connection between the I/O of modules with 40-way connectors **1** and the sensors, preactuators, or intermediate terminal blocks.

These preassembled cordsets comprise:

- At one end, a 40-way connector **2** with either of the following:
  - One sheath containing 20 wires with a cross-section of 0.34 mm<sup>2</sup> (AWG 22) (**BMXFCW●●1**)
  - Two sheaths **3**, each containing 20 wires with a cross-section of 0.34 mm<sup>2</sup> (AWG 22) (**BMXFCW●●3**)
- At the other end, color-coded flying leads **4** conforming to standard DIN47100

##### Preassembled cordsets with 40-way connector and HE 10 connector(s)

Two types of cordset can be used for connecting the I/O of modules **1** with 40-way connectors to Modicon Telefast ABE7 rapid wiring connection and adaptation interfaces (**1**).

These preassembled cordsets comprise:

- At one end, a 40-way connector **2** with either of the following:
  - One sheath containing 20 wires (**BMXFCC●●1**)
  - Two sheaths **3** each containing 20 wires (**BMXFCC●●3**)
- At the other end, one or two HE 10 connectors **5**

#### Connection to TeSys Quickfit system

**BMXDDI3202K/6402K** input modules, **BMXDDO3202K/6402K** output modules, and **BMXDDM3202K** mixed I/O modules with 40-way connectors are designed, amongst other things, for use in conjunction with the TeSys Quickfit mounting system via the **LU9G02** splitter module **6** (for 8 motor starters).

The splitter modules are easily connected using **7 BMXFCC●●1/●●3** preassembled cordsets.

(1) For more information, please refer to the "Telefast Pre-wired system» catalog or visit our website [www.se.com](http://www.se.com).

#### Complementary characteristics

The following characteristics complement those introduced in the selection guide on pages 4/2 to 4/7.

#### DC input modules BMXDDI16●●/1604T/3202K/3232/6402K and BMXDAl1602

- Input impedance at nominal voltage: 6.4 to 19.2 kΩ, depending on model
- Reverse polarity: Protection for modules BMXDDI1602/1603/3202K/3203
- Paralleling of inputs (1): Yes, for modules BMXDDI1602/1603/3232/3203
- Dielectric strength between groups of channels: 500 V  $\overline{\text{---}}$  for modules BXDDI3202K/3203/3232/6402K
- Temperature derating for module BMXDDI1604T: No derating up to 40 °C/104 °F, a maximum of 25% of inputs at state 1 at 70 °C/158 °F

#### AC input modules BMXDAl16●●/08●●

- Input frequency: 47 to 63 Hz
- Current peak on activation at nominal voltage: 5 to 380 mA depending on model
- Input impedance at nominal voltage and F = 55 Hz: 6 to 28 kΩ, depending on model

#### Triac output module BMXDAO1605

- Current via common: 2.4 A
- Current for the 4 commons together: 4.8 A

#### Isolated triac output module BMXDAO1615

- Current per module: 10 A maximum continuous

#### DC transistor output modules BMXDDO16●●/3202K/6402K

- Dielectric strength between groups of channels: 500 V  $\overline{\text{---}}$  for modules BMXDDO3202K/6402K

#### Relay output modules BMXDRA08●●●/1605 and BMXDRC0805

- Protection against AC inductive overvoltage: Use an RC circuit or ZNO surge limiter appropriate to the voltage in parallel on each output.
- Protection against DC inductive overvoltage: Use a discharge diode on each output.

#### Mixed I/O relay module BMXDdM16025

- Input impedance at nominal voltage: 6.8 kΩ
- Dielectric strength between groups of inputs: 500 V  $\overline{\text{---}}$

#### DC mixed I/O modules BMXDdM16022/3202K

- Input impedance at nominal voltage: 6.8 to 9.6 kΩ, depending on model
- Reverse polarity on the inputs: Protection
- Paralleling of outputs: Yes, for a maximum of 2 outputs for module **BMXDdM16022** and a maximum of 3 outputs for module **BMXDdM3202K**

(1) For further information, please consult our website at [www.se.com](http://www.se.com).

(2) EcoStruxure Control Expert software continues the Unity Pro range of software and corresponds to versions  $\geq$  14 of Unity Pro.

References							
X80 Discrete input modules							
Type	Input voltage	Connection via (1)	IEC/EN 61131-2 conformity	No. of channels (common x channels per group)	Reference	Weight kg/lb	
☐	24 V (positive logic)	20-way caged, screw clamp, or spring-type removable terminal block	Type 3	16 inputs (1 x 16)	<a href="#">BMXDDI1602</a>	0.115/0.254	
		One 40-way connector	Type 1	32 inputs (2 x 16)	<a href="#">BMXDDI3202K</a>	0.110/0.243	
		Two 40-way connectors	Non-type	64 inputs (4 x 16)	<a href="#">BMXDDI6402K</a>	0.145/0.320	
	24 V (positive/negative logic)	20-way caged, screw clamp, or spring-type removable terminal block	Non-type	16 inputs (1 x 16)	<a href="#">BMXDAI1602</a>	0.115/0.254	
		12/24 V (positive/negative logic)	40-way caged or spring-type removable terminal block	Type 3	32 inputs (2 x 16)	<a href="#">BMXDDI3232</a>	0.137/0.302
		48 V (positive logic)	20-way caged, screw clamp, or spring-type removable terminal block	Type 1	16 inputs (1 x 16)	<a href="#">BMXDDI1603</a>	0.115/0.254
40-way caged or spring-type removable terminal block	Type 3		32 inputs (2 x 16)	<a href="#">BMXDDI3203</a>	0.137/0.302		
~	125 V (positive logic)	20-way caged, screw clamp, or spring-type removable terminal block	Non-type	16 inputs (1 x 16)	<a href="#">BMXDDI1604T</a>	0.144/0.317	
		24 V	20-way caged, screw clamp, or spring-type removable terminal block	Type 1	16 inputs (1 x 16)	<a href="#">BMXDAI1602</a>	0.115/0.254
			48 V	20-way caged, screw clamp, or spring-type removable terminal block	Type 3	16 inputs (1 x 16)	<a href="#">BMXDAI1603</a>
~	100...120 V	20-way caged, screw clamp, or spring-type removable terminal block	Type 3	8 isolated inputs (8 x 1)	<a href="#">BMXDAI0814</a>	0.115/0.254	
		20-way caged, screw clamp, or spring-type removable terminal block	Type 3	16 inputs (1 x 16)	<a href="#">BMXDAI1604</a>	0.115/0.254	
		40-way caged or spring-type removable terminal block	Type 1	16 isolated inputs	<a href="#">BMXDAI1614</a>	0.157/0.346	
	200...240 V	40-way caged or spring-type removable terminal block	Non-type at 50 Hz Type 1 at 60 Hz	16 isolated inputs	<a href="#">BMXDAI16142</a> (2)	0.157/0.346	
		20-way caged, screw clamp, or spring-type removable terminal block	Type 2	8 inputs (1 x 8)	<a href="#">BMXDAI0805</a>	0.120/0.265	
		40-way caged or spring-type removable terminal block	Type 1	16 isolated inputs	<a href="#">BMXDAI1615</a>	0.157/0.346	



BMXDDI160●●  
BMXDAI08●●●●/160●



BMXDAI161●●



BMXDDI3202K



BMXDDI6402K

(1) 64-channel modules have 2 connectors and therefore require 2 connection cables.  
 (2) BMXDAI16142 is optimized for 60Hz application, e.g. Quantum modules, while BMXDAI1614 is compatible for both 50Hz and 60 Hz.



4

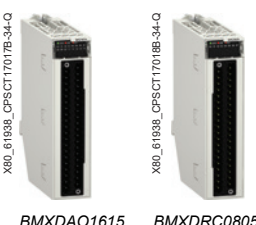
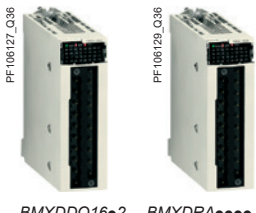

### References

#### X80 Discrete output modules

Type	Output voltage	Connection via (1)	IEC/EN 61131-2 conformity		No. of channels (common x channels per group)	Reference	Weight kg/lb
			Inputs	Outputs			
transistor	24 V (positive logic)	20-way caged, screw clamp, or spring-type removable terminal block	Yes		16 outputs (1 x 16)	<a href="#">BMXDDO1602</a>	0.120/0.265
	24 V (negative logic)	20-way caged, screw clamp, or spring-type removable terminal block	Yes		16 outputs (1 x 16)	<a href="#">BMXDDO1612</a>	0.120/0.265
	24 V (positive logic)	One 40-way connector	Yes		32 outputs (2 x 16)	<a href="#">BMXDDO3202K</a>	0.110/0.243
		Two 40-way connectors	Yes		64 outputs (4 x 16)	<a href="#">BMXDDO6402K</a>	0.150/0.331
triac	100...240 V	20-way caged, screw clamp, or spring-type removable terminal block	Yes		16 outputs (4 x 4)	<a href="#">BMXDAO1605</a>	0.140/0.309
	24...240 V	40-way caged or spring-type removable terminal block	Yes		16 isolated outputs	<a href="#">BMXDAO1615</a>	0.250/0.551
relay	100...150 V	20-way caged, screw clamp, or spring-type removable terminal block	Yes		8 normally open isolated relay outputs	<a href="#">BMXDRA0804T</a>	0.178/0.392
relay	24 V	20-way caged, screw clamp, or spring-type removable terminal block	Yes		8 normally open isolated relay outputs	<a href="#">BMXDRA0805</a>	0.145/0.320
	24...240 V		Yes		8 normally open isolated relay outputs	<a href="#">BMXDRA0815</a>	0.210/0.463
	24...125 V	20-way caged, screw clamp, or spring-type removable terminal block	Yes		16 normally open relay outputs (2 x 8)	<a href="#">BMXDRA1605</a>	0.150/0.331
	24...240 V	40-way caged or spring-type removable terminal block	Yes		8 normally open and normally closed isolated relay outputs	<a href="#">BMXDRC0805</a>	0.189/0.417

#### X80 Discrete mixed I/O modules

Type	Voltage		Connection via (2)	IEC/EN 61131-2 conformity		No. of channels (common x channels per group)		Reference	Weight kg/lb
	Inputs	Outputs		Inputs	Outputs	Inputs	Outputs		
transistor	24 V	24 V	20-way caged, screw clamp, or spring-type removable terminal block	Type 3	Yes	8 (1 x 8)	8 (1 x 8)	<a href="#">BMXDDM16022</a>	0.115/0.254
relay	24 V	24...240 V	20-way caged, screw clamp, or spring-type removable terminal block	Type 3	Yes	8 (1 x 8)	8 (1 x 8)	<a href="#">BMXDDM16025</a>	0.135/0.298
transistor	24 V	24 V	One 40-way connector	Type 1	Yes	16 (1 x 16)	16 (1 x 16)	<a href="#">BMXDDM3202K</a>	0.110/0.243

(1) 64-channel modules have 2 connectors and therefore require 2 connection cables.

PF106141W-outlabel\_M28

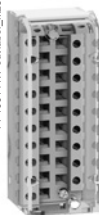

BMXFTB2000

PF106144\_M08



BMXFTW01

PF106145\_M08



BMXFCW01

PF106177\_M08.tif



BMXFCW03

PF106146\_M08



BMXFCC01

#### References (continued)

##### Removable terminal blocks

Description	For use with	Type	Reference	Weight kg/lb
20-way removable terminal blocks	For module with 20-way removable terminal block	Caged	<a href="#">BMXFTB2000</a>	0.093/ 0.205
		Screw clamp	<a href="#">BMXFTB2010</a>	0.075/ 0.165
		Spring	<a href="#">BMXFTB2020</a>	0.060/ 0.132
40-way removable terminal blocks	For module with 40-way removable terminal block	Caged	<a href="#">BMXFTB4000</a>	0.166/ 0.366
		Spring	<a href="#">BMXFTB4020</a>	0.098/ 0.216

##### Preassembled cordsets for 16- and 32-channel I/O modules with removable terminal block

Description	Composition	Cross-section	Length m/ft	Reference	Weight kg/lb
Preassembled cordsets with one end with flying leads	One 20-way spring-type removable terminal block (BMXFTB2020) and one end with color-coded flying leads	0.324 mm <sup>2</sup> / AWG 22	3/9.84	<a href="#">BMXFTW301</a>	0.850/ 1.874
			5/16.4	<a href="#">BMXFTW501</a>	1.400/ 3.086
			10/32.8	<a href="#">BMXFTW1001</a>	2.780/ 6.129
Preassembled cordsets with one end with flying leads	One 40-way spring-type removable terminal block (BMXFTB4020) and one end with color-coded flying leads	0.324 mm <sup>2</sup> / AWG 22	3/9.84	<a href="#">BMXFTW305</a>	0.940/ 2.072
			5/16.4	<a href="#">BMXFTW505</a>	1.460/ 3.218

##### Preassembled cordsets for 16-, 32-, and 64-channel I/O modules with 40-way connectors

Description	No. of sheaths	Composition	Cross-section	Length m/ft	Reference	Weight kg/lb
Preassembled cordsets with one end with flying leads	1 x 20 wires (16 channels)	One 40-way connector and one end with color-coded flying leads	0.324 mm <sup>2</sup> / AWG 22	3/9.84	<a href="#">BMXFCW301</a>	0.820/ 1.808
				5/16.4	<a href="#">BMXFCW501</a>	1.370/ 3.020
				10/32.8	<a href="#">BMXFCW1001</a>	2.770/ 6.107
Preassembled cordsets for Modicon Telefast ABE7 sub-bases	2 x 20 wires (32 channels) (1)	One 40-way connector and two ends with color-coded flying leads	0.324 mm <sup>2</sup> / AWG 22	3/9.84	<a href="#">BMXFCW303</a>	0.900/ 1.984
				5/16.4	<a href="#">BMXFCW503</a>	1.490/ 3.285
				10/32.8	<a href="#">BMXFCW1003</a>	2.960/ 6.526
Preassembled cordsets for Modicon Telefast ABE7 sub-bases	1 x 20 wires (16 channels)	One 40-way connector and one HE 10 connector	0.324 mm <sup>2</sup> / AWG 22	0.5/1.64	<a href="#">BMXFCC051</a>	0.140/ 0.309
				1/3.28	<a href="#">BMXFCC101</a>	0.195/ 0.430
				2/6.56	<a href="#">BMXFCC201</a>	0.560/ 1.235
				3/9.84	<a href="#">BMXFCC301</a>	0.840/ 1.852
				5/16.4	<a href="#">BMXFCC501</a>	1.390/ 3.064
				10/32.8	<a href="#">BMXFCC1001</a>	2.780/ 6.123
				0.5/1.64	<a href="#">BMXFCC053</a>	0.210/ 0.463
				1/3.28	<a href="#">BMXFCC103</a>	0.350/ 0.772
				2/6.56	<a href="#">BMXFCC203</a>	0.630/ 1.389
				3/9.84	<a href="#">BMXFCC303</a>	0.940/ 2.072
				5/16.4	<a href="#">BMXFCC503</a>	1.530/ 3.373
				10/32.8	<a href="#">BMXFCC1003</a>	3.000/ 6.614

(1) 64-channel modules have 2 connectors and therefore require 2 connection cables.

# Modicon X80 module platform

X80 I/O modules  
Analog input modules

Applications

Analog inputs



Type of input	Isolated low-level inputs, voltage, thermocouples, temperature probes, resistors		Isolated high-level inputs	Non-isolated high-level inputs	Isolated high-level inputs
Type	Multirange		Voltage/current		
Range	Voltage	± 40 mV, ± 80 mV, ± 160 mV, ± 320 mV, ± 640 mV, ± 1.28 V		± 10 V, 0...10 V, 0...5 V, 1..5 V, ± 5 V	
	Current	-		0...20 mA, 4...20 mA, ± 20 mA	
	Thermocouple	Thermocouples, type B, E, J, K, L, N, R, S, T, U		-	
	Temperature probe	2-, 3- or 4-wire temperature probes, type Pt100, JPt100, Pt1000, JPt1000, Ni100, Ni1000 (in accordance with DIN43760), and Cu 10		-	
	Resistor	2-, 3- or 4-wire resistors, 400 Ω or 4000 Ω		-	
Modularity	4 inputs	8 inputs	4 inputs	8 inputs	
Acquisition period	400 ms for the 4 inputs	400 ms for the 8 inputs	Fast: 1 + (1 x no. of declared channels) ms Default: 5 ms for the 4 channels	Fast: 1 + (1 x no. of declared channels) ms Default: 9 ms for the 8 channels	
Conversion time	-				
Resolution	15 bits + sign		16 bits		
Dimension	W x H x D				
	32 x 100 x 86 mm / 1.25 x 3.93 x 3.38 in.				
Isolation	Between channels		750 V ---		300 V ---
	Between channels and bus		1400 V ---		
	Between channels and ground		750 V ---		1400 V ---
Connection	Directly to the module	Via one 40-way connector	Via two 40-way connectors	Via <b>BMXFTB20●0</b> 20-way caged, screw clamp, or spring-type removable terminal block	Via <b>BMXFTB28●0</b> 28-way caged or spring-type removable terminal block
	Via preassembled cordsets	<b>BMXFCW●01S</b> cordsets with one end with color-coded flying leads (3 or 5 m/9.84 or 16.4 ft)		<b>BMXFTW●01S</b> cordsets with one end with color-coded flying leads (3 or 5 m/9.84 or 16.4 ft)	<b>BMXFTW●08S</b> cordsets with one end with color-coded flying leads (3 or 5 m/9.84 or 16.4 ft)
Compatibility with Modicon Telefast ABE7 pre-wired system (1)	Connection sub-base	4-channel sub-base for direct connection of 4 thermocouples plus connection and provision of cold junction compensation		4-channel sub-base for direct connection of 4 inputs, delivers and distributes 4 protected isolated power supplies	8-channel sub-base for direct connection of 8 current/voltage inputs
	Type of connection sub-base	<b>ABE7CPA412</b>		<b>ABE7CPA410</b>	<b>ABE7CPA02/03/31/31E</b> <b>ABE7CPA02/31/31E</b>
	Type of preassembled cordsets	<b>BMXFCA●●2</b> (1.5, 3, or 5 m/4.92, 9.84, or 16.4 ft)		<b>BMXFCA●●0</b> (1.5, 3, or 5 m/4.92, 9.84, or 16.4 ft)	<b>BMXFCA●●0</b> (1.5 or 3 m/4.92 or 9.84 ft)

References

<b>BMXART0414</b>	<b>BMXART0814</b>	<b>BMXAMI0410</b>	<b>BMXAMI0800</b>	<b>BMXAMI0810</b>
-------------------	-------------------	-------------------	-------------------	-------------------

Page

4/24

(1) For more information, please refer to the "Telefast Pre-wired system -- Modicon ABE7 IP20 connection sub-bases" catalog or visit our website [www.se.com](http://www.se.com).

# Modicon X80 module platform

X80 I/O modules

Analog output modules and mixed I/O modules

Applications	Analog outputs	Mixed analog I/O	
--------------	----------------	------------------	--



Type of I/O	Isolated high-level outputs	Non-isolated high-level outputs	Non-isolated high-level inputs and outputs
Type	Voltage/current	Current	Voltage/current
Range	Voltage ± 10 V Current 0–20 mA, 4–20 mA	–	Inputs: ± 10 V, 0...10 V, 0...5 V, 1..5 V Outputs: ± 10 V
Modularity	2 outputs	4 outputs	8 outputs
Acquisition period (inputs)	–	–	Fast: 1 + (1 x no. of declared channels) ms Default: 5 ms for the 4 channels
Conversion time (outputs)	≤ 1 ms	≤ 4 ms	≤ 1 ms
Resolution	Inputs – Outputs 15 bits + sign	–	14...12-bit in U range 12-bit in I range 12-bit in U range 11-bit in I range
Dimension	W x H x D 32 x 100 x 86 mm/1.25 x 3.93 x 3.38 in.		
Isolation	Between groups of input or output channels Between channels Between channels and bus Between channels and ground	– 750 V --- 1400 V --- 1400 V ---	750 V --- –
Connection	Directly to the module Via preassembled cordsets	Via <b>BMXFTB20●0</b> 20-way caged, screw clamp, or spring-type removable terminal block <b>BMXFTW●01S</b> cordsets with one end with color-coded flying leads (3 or 5 m/9.84 or 16.4 ft)	
Compatibility with Modicon Telefast ABE7 pre-wired system (1)	Connection sub-base Type of connection sub-base Type of preassembled cordsets	4-channel sub-base for direct connection of 2/4 current/voltage outputs <b>ABE7CPA21</b> <b>BMXFCA●●0</b> (1.5, 3, or 5 m/4.92, 9.84, or 16.4 ft)	8-channel sub-base for direct connection of 8 current/voltage inputs <b>ABE7CPA02</b> <b>BMXFCA●●2</b> (1.5 or 3 m/4.92 or 9.84 ft)

References	<b>BMXAMO0210</b>	<b>BMXAMO0410</b>	<b>BMXAMO0802</b>	<b>BMXAMM0600</b>
------------	-------------------	-------------------	-------------------	-------------------

Page	4/24
------	------

(1) For more information, please refer to the "Telefast Pre-wired system -- Modicon ABE7 IP20 connection sub-bases" catalog or visit our website [www.se.com](http://www.se.com).

#### Presentation

The Modicon X80 analog I/O modules offer comprises:

- 5 analog input modules:
  - 2 modules with 4 and 8 isolated channels, low-level voltage, thermocouples, Pt, JPt, Ni, or Cu temperature probes and resistors, 15 bits + sign  
**BMXART0414/0814**
  - 1 module with 4 high-speed isolated analog channels, high-level voltage or current, 16 bits **BMXAMI0410**
  - 2 modules with 8 high-speed non-isolated analog channels, high-level voltage or current, 15 bits + sign **BMXAMI0800/0810**
- 3 analog output modules:
  - 1 module with 2 isolated analog channels, high-level voltage or current, 15 bits + sign **BMXAMO0210**
  - 1 module with 4 isolated analog channels, high-level voltage or current, 15 bits + sign **BMXAMO0410**
  - 1 module with 8 non-isolated analog channels, high-level current, 15 bits + sign **BMXAMO0802**
- 1 mixed analog I/O module with 4 input channels and 2 output channels (non-isolated), voltage or current, 12 to 14 bits according to type of channel and range **BMXAMM0600**

Analog I/O modules are equipped with a connector for a 20 or 28-way removable terminal block, except for **BMXART0414/0814** analog input modules for thermocouples/temperature probes, which are equipped with one or two 40-way connector(s).

All analog modules occupy a single slot in **BMEXBP●●●** or **BMXXBP●●●** racks. These modules can be installed in any slot in the rack, except the first two (PS and 00), which are reserved for the power supply module and the processor module respectively.

The power supply for the analog functions is supplied by the backplane bus (3.3 V and 24 V). Analog I/O modules are hot-swappable (see [page 4/10](#)).

#### Description

**BMXAM●/ART** analog I/O modules are standard format (1 slot). They have a case, which provides IP20 protection of the electronics, and are locked into position by a captive screw.

#### I/O modules connected via 20 or 28-way removable terminal block

**BMXAM●** analog I/O modules feature the following:

- 1 A rigid body providing support and protection for the electronic card
- 2 A module reference marking (a label is also visible on the right-hand side of the module)
- 3 A module and channel status display block
- 4 A connector taking the 20 or 28-way removable screw clamp or spring-type terminal block for directly connecting the sensors or preactuators to the module

To be ordered separately (see [page 4/25](#)):

- 5 **BMXFTB20●0** or **BMXFTB28●0** 20 or 28-way removable terminal block (referencing label supplied with each I/O module) or pre-wired cables with:
  - A 20-way terminal block at one end and flying leads at the other (**BMXFTW●01S**)
  - A 28-way terminal block at one end and flying leads at the other (**BMXFTW●08S**)
  - A 20 or 28-way terminal block and a 25-way SUB-D connector (**BMXFCA●●0** or **BMXFTA●●0**), for connection to Modicon Telefast ABE7 sub-bases

#### I/O modules connected via 40-way connector

**BMXART** analog input modules have the following on the front panel:

- 1 A rigid body providing support and protection for the electronic card
- 2 A module reference marking (a label is also visible on the right-hand side of the module)
- 3 A module and channel status display block
- 4 One (or two) 40-way connector(s) for connecting the sensors

To be ordered separately (see [page 4/25](#)):

- 5 Pre-wired cables with:
  - A 40-way connector at one end and flying leads at the other (**BMXFCW●01S**)
  - A 40-way connector and a 25-way SUB-D connector (**BMXFCA●●2**) for direct connection to Modicon Telefast ABE7 sub-bases

To be ordered separately (see [page 4/25](#)):

- A **BMXXSP●●00** shielding connection kit to help protect against electrostatic discharge, consisting of a metal bar and two sub-bases for mounting on the rack supporting the analog modules
- A set of **STBXSP3020** clamping rings for the shielding braids of analog signal cables

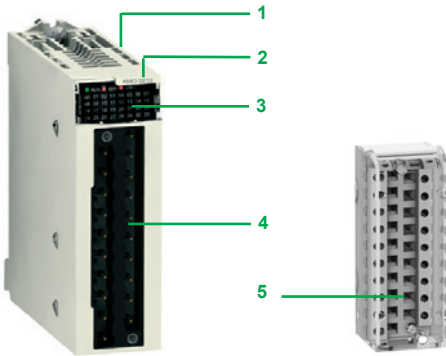

Module for connection via 20 or 28-way removable terminal block

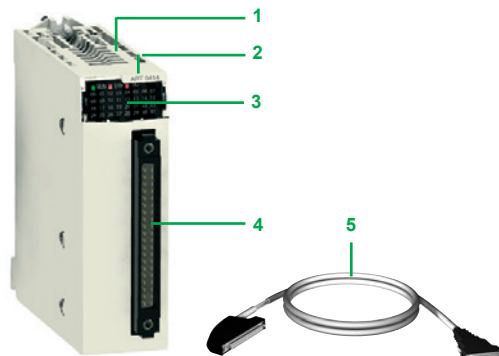

Module for connection via 40-way connector



BMXFTW01S cordset  
(with 20-way removable terminal block at one end and flying leads at the other)

#### Connecting modules with removable terminal blocks

##### BMXAMI0410, BMXAMO, and BMXAMM modules with 20-way terminal block

The 20-way removable terminal blocks (BMXFTB2000) are the same as those used for discrete I/O modules (screw clamp, caged, or spring-type) (see [page 4/25](#)). One version of the removable terminal block is equipped with a 3 or 5 m/9.84 or 16.4 ft cordset with color-coded flying leads (BMXFTW01S). These preassembled cordsets with reinforced shielding have color-coded flying leads at the other end 1.

##### BMXAMI0800/0810 modules with 28-way terminal block

The 28-way removable terminal blocks are caged (BMXFTB2800) or spring-type (BMXFTB2820). One version of the removable terminal block is equipped with a 3 or 5 m/9.84 or 16.4 ft cordset with color-coded flying leads (BMXFTW08S). These preassembled cordsets with reinforced shielding have color-coded flying leads at the other end 1.

#### Connecting modules with 40-way connectors

##### BMXART014 modules with 40-way connectors

Two types of cordset are available:

- Preassembled cordsets with reinforced shielding (BMXFCW01S) which have color-coded flying leads at the other end 2. Available in 3 or 5 m/9.84 or 16.4 ft lengths, they enable easy direct wire-to-wire connection of the analog sensors via terminal blocks.
- Preassembled cordsets with reinforced shielding (BMXFCA02) which have a 25-way SUB-D connector at the other end 3. Available in 1.5, 3, or 5 m/4.92, 9.84, or 16.4 ft lengths, they enable direct connection to the Modicon Telefast ABE7CPA412 sub-base (see below).

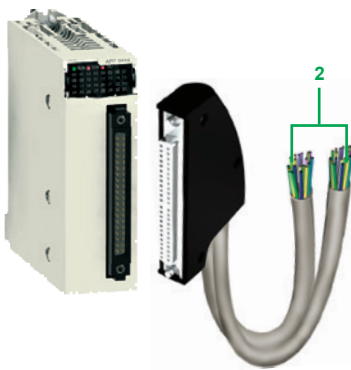

BMXFCW01S cordset  
(with 40-way connector at one end and flying leads at the other)

#### Use with Modicon Telefast ABE7 sub-bases

Using the Modicon Telefast ABE7 pre-wired system makes it easier to install the modules since the inputs (or outputs) can be accessed via screw clamp terminals. Seven special sub-bases are available:

##### Modicon Telefast ABE7CPA410 sub-base

The Modicon Telefast ABE7CPA410 sub-base is mainly used in conjunction with the BMXAMI0410 voltage/current analog 4-input module. This sub-base allows you to:

- Directly connect 4 sensors
- Remotely locate the input terminals in voltage mode
- Power the 4 to 20 mA conditioning units one channel at a time with a 24 V voltage, protected and limited to 25 mA, while maintaining isolation between channels
- Help protect the current impedance matching resistors integrated in the sub-base against overvoltages

Connection is via the BMXFCA000 cordset (1.5, 3, or 5 m/4.92, 9.84, or 16.4 ft).

##### Modicon Telefast ABE7CPA412 sub-base

The Modicon Telefast ABE7CPA412 sub-base is specially designed as a wiring interface for the BMXART0414 and BMXART0814 thermocouple modules. This sub-base allows you to:

- Connect 4 thermocouple probes
- Provide external cold junction compensation with a temperature probe integrated in the sub-base
- Provide continuity of the shielding

The BMXART0814 module requires two Modicon Telefast ABE7CPA412 sub-bases. The connection with each sub-base is made via a BMXFCA002 cordset (1.5, 3, or 5 m/4.92, 9.84, or 16.4 ft).

##### Modicon Telefast ABE7CPA21 sub-base

The Modicon Telefast ABE7CPA21 sub-base is compatible with the BMXAMO0210 output module. This sub-base allows you to:

- Directly connect 2 current/voltage outputs
- Provide continuity of the shielding

Connection is via the BMXFCA000 cordset 3 (1.5, 3, or 5 m/4.92, 9.84, or 16.4 ft).

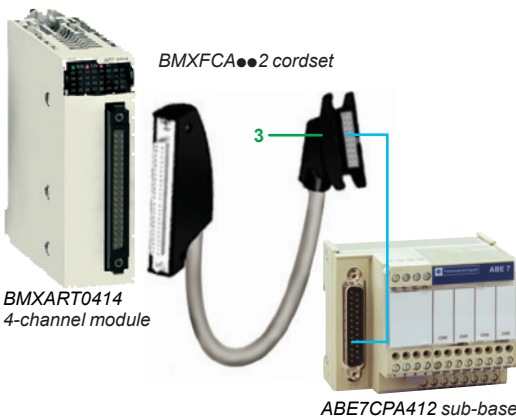

BMXART0414  
4-channel module

ABE7CPA412 sub-base



DIA3ED2160602EN

#### Use with Modicon Telefast ABE7 sub-bases (continued)

##### Modicon Telefast ABE7CPA02 sub-base

The Modicon Telefast **ABE7CPA02** sub-base can be used in combination with:

- **BMXAMI0800/0810** analog current input modules with 8 inputs
- **BMXAMO0802** analog current output modules with 8 outputs

This sub-base allows you to:

- Connect the 8 analog inputs or outputs point-to-point
- Provide continuity of the shielding

**BMXAMI0800/0810** modules are connected via **BMXFTA●●0** 1.5 or 3 m/4.92 or 9.84 ft cables.

The **BMXAMO0802** module is connected via **BMXFTA●●2** 1.5, 3, or 5 m/4.92, 9.84, or 16.4 ft cables.

##### Modicon Telefast ABE7CPA03 sub-base

The Modicon Telefast **ABE7CPA03** sub-base can be used in combination with the **BMXAMI0800** voltage/current analog 8-input module.

This sub-base allows you to:

- Directly connect 8 analog inputs
- Power the current inputs one channel at a time with a voltage of 24 V that is protected and limited to 25 mA
- Provide continuity of the shielding

The **BMXAMI0800** module is connected via **BMXFTA●●0** 1.5 or 3 m/4.92 or 9.84 ft cables.

##### Modicon Telefast ABE7CPA31/31E sub-bases

The Modicon Telefast **ABE7CPA31/31E** sub-bases can be used in combination with the **BMXAMI0800/0810** voltage/current analog 8-input modules.

These sub-bases allow you to:

- Directly connect 8 analog inputs
- Power the current inputs one channel at a time with 24 V converters
- Provide continuity of the shielding

**BMXAMI0800/0810** modules are connected via **BMXFTA●●0** 1.5 or 3 m/4.92 or 9.84 ft cables.

#### Complementary characteristics

##### BMXART0414/0814 analog input modules

**BMXART0414/0814** modules are multirange input modules with 4 or 8 low-level isolated inputs (15 bits + sign) respectively.

Depending on the choice made during configuration, the modules offer, for each of the inputs, the following ranges:

- Temperature probe: Pt100, JPt100, Pt1000, JPt1000, Cu10, Ni100, or Ni1000 (in accordance with DIN43760), with open-circuit detection
- Thermocouple: B, E, J, K, L, N, R, S, T, or U with broken wire detection
- Resistor: 0...400 or 0...4000  $\Omega$ , 2-, 3-, or 4-wire
- Voltage:  $\pm 40$  mV,  $\pm 80$  mV,  $\pm 160$  mV,  $\pm 320$  mV,  $\pm 640$  mV,  $\pm 1.28$  V

##### BMXAMI0410 analog input module

The **BMXAMI0410** module is a high-level analog input module with 4 isolated inputs (16 bits).

Used with sensors or transmitters, it performs monitoring, measurement, and process control functions for continuous processes.

The module offers the following ranges for each of the inputs depending on the choice made during configuration:

- Voltage  $\pm 10$  V,  $\pm 5$  V, 0...10 V, 0...5 V, and 1...5 V
- Current 0–20 mA, 4–20 mA, and  $\pm 20$  mA

##### BMXAMI0800/0810 analog input modules

**BMXAMI0800/0810** analog input modules have 8 high-level isolated/non-isolated analog inputs (15 bits + sign).

The modules offer the following ranges for each of the inputs depending on the choice made during configuration:

- Voltage:  $\pm 10$  V, 0...10 V, 0...5 V, 1...5 V,  $\pm 5$  V
- Current: 0–20 mA and 4–20 mA



#### Complementary characteristics (continued)

##### BMXAMO0210 analog output module

The **BMXAMO0210** module has 2 high-level isolated outputs (15 bits + sign).  
The **BMXAMO0210** module offers the following ranges for each of the inputs depending on the choice made during configuration:

- Voltage:  $\pm 10$  V
- Current: 0–20 mA and 4–20 mA

##### BMXAMO0410/0802 analog output modules

**BMXAMO0410/0802** analog output modules have 4 or 8 high-level isolated/non-isolated analog outputs (16 bits/15 bits + sign).

The **BMXAMO0410** module offers the following ranges for each of the outputs depending on the choice made during configuration:

- Voltage:  $\pm 10$  V
- Current: 0–20 mA and 4–20 mA

The **BMXAMO0802** module offers the current ranges 0–20 mA and 4–20 mA.

##### BMXAMM0600 analog mixed I/O module

The **BMXAMM0600** mixed module is a non-isolated I/O module with 4 inputs (14/12 bits) and 2 outputs (12 bits). The module offers the following ranges for each of the inputs or outputs depending on the choice made during configuration:

- Voltage:  $\pm 10$  V, 0...10 V, 0...5 V, and 1...5 V
- Current: 0–20 mA and 4–20 mA

#### References

##### X80 Analog input modules (1)

Type of input	Input signal range	Resolution	Connection via	No. of channels	Reference	Weight kg/lb
Isolated high-level inputs	$\pm 10$ V, 0...10 V, 0...5 V, 1...5 V, $\pm 5$ V, 0–20 mA, 4–20 mA, $\pm 20$ mA	16 bits	20-way caged, screw clamp, or spring-type removable terminal block	4 channels	<a href="#">BMXAMI0410</a>	0.143/ 0.315
Non-isolated high-level inputs	$\pm 10$ V, 0...10 V, 0...5 V, 1...5 V, $\pm 5$ V, 0–20 mA	15 bits + sign	28-way caged or spring-type removable terminal block	8 channels	<a href="#">BMXAMI0800</a>	0.175/ 0.386
Isolated high-level inputs	$\pm 10$ V, 0...10 V, 0...5 V, 1...5 V, $\pm 5$ V, 0–20 mA	15 bits + sign	28-way caged or spring-type removable terminal block	8 channels	<a href="#">BMXAMI0810</a>	0.175/ 0.386
Isolated low-level inputs	Temperature probe, thermocouple, $\pm 40$ mV, $\pm 80$ mV, $\pm 160$ mV, $\pm 320$ mV, $\pm 640$ mV, $\pm 1.28$ V	15 bits + sign	40-way connector	4 channels	<a href="#">BMXART0414</a>	0.135/ 0.298
				8 channels	<a href="#">BMXART0814</a>	0.165/ 0.364

##### X80 Analog output modules (1)

Type of outputs	Output signal range	Resolution	Connection via	No. of channels	Reference	Weight kg/lb
Isolated high-level outputs	$\pm 10$ V, 0–20 mA, 4–20 mA	16 bits	20-way caged, screw clamp, or spring-type removable terminal block	2 channels	<a href="#">BMXAMO0210</a>	0.144/ 0.317
High-level outputs isolated	$\pm 10$ V, 0–20 mA, 4–20 mA	15 bits + sign	20-way caged, screw clamp, or spring-type removable terminal block	4 channels	<a href="#">BMXAMO0410</a>	0.175/ 0.386
Non-isolated high-level inputs	0–20 mA, 4–20 mA	15 bits + sign	20-way caged, screw clamp, or spring-type removable terminal block	8 channels	<a href="#">BMXAMO0802</a>	0.175/ 0.386

##### X80 Analog mixed I/O module (1)

Type of I/O	Signal range	Resolution	Connection via	No. of channels	Reference	Weight kg/lb
Mixed I/O, non-isolated	$\pm 10$ V, 0...10 V, 0...5 V, 1...5 V, 0–20 mA, 4–20 mA	14 bits or 12 bits depending on the range	20-way caged, screw clamp, or spring-type removable terminal block	Inputs: 4 channels Outputs: 2 channels	<a href="#">BMXAMM0600</a>	0.155/ 0.342

(1) Typical consumption: See the power consumption table available on our website [www.se.com](http://www.se.com).

PF106147



BMXAMO0210

PF106148



BMXART0414

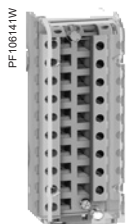

BMXFTB20●0



BMXFTW●01S



ABE7CPA41●/21



BMXFCA●●0



BMXFCA●●2

## References (continued)

## Connection accessories for analog modules (1)

Description	For use with modules	Type, composition	Length	Reference	Weight kg/lb
20-way removable terminal block	BMXAMI0410	Caged	–	BMXFTB2000	0.093/ 0.205
	BMXAMO0210	Screw clamp	–	BMXFTB2010	0.075/ 0.165
	BMXAMO0410		–	BMXFTB2020	0.060/ 0.132
28-way removable terminal block	BMXAMI0800	Caged	–	BMXFTB2800	0.111/ 0.245
	BMXAMI0810	Spring	–	BMXFTB2820	0.080/ 0.176
Preassembled cordset	BMXAMI0410	One 20-way terminal block (BMXFTB2020) and one end with color-coded flying leads	3 m/9.84 ft	BMXFTW301S	0.470/ 1.036
	BMXAMO0210		5 m/16.4 ft	BMXFTW501S	0.700/ 1.543
	BMXAMO0410	One 28-way removable terminal block (BMXFTB2820) and one end with color-coded flying leads	3 m/9.84 ft	BMXFTW308S	0.435/ 0.959
	BMXAMO0802		5 m/16.4 ft	BMXFTW508S	0.750/ 1.653
	BMXAMI0800	One 40-way connector and one end with color-coded flying leads	3 m/9.84 ft	BMXFCW301S	0.480/ 1.058
	BMXAMI0814		5 m/16.4 ft	BMXFCW501S	0.710/ 1.565

## Modicon Telefast ABE7 pre-wired system

Description	For use with modules	Type, composition	Length or connection technology	Reference	Weight kg/lb
Modicon Telefast ABE7 sub-base	BMXAMI0410	Distribution of isolated power supplies. Delivers 4 protected isolated power supplies for 4–20 mA inputs. Direct connection of 4 inputs	Screws	ABE7CPA410	0.180/ 0.397
	BMXART0414	Connection and provision of cold-junction compensation for thermocouples Direct connection of 4 inputs	Screws	ABE7CPA412	0.180/ 0.397
	BMXART0814 (2)		Screws	ABE7CPA21	0.210/ 0.463
	BMXAMO0210	Direct connection of 2/4 outputs	Screws	ABE7CPA02	0.317/ 0.699
	BMXAMI0800	Point-to-point connection of 8 I/O	Screws	ABE7CPA03	0.307/ 0.677
	BMXAMI0800	Direct connection of 8 inputs. Delivers 8x 24 V $\pm$ power supplies limited to 25 mA to the 8 current inputs	Screws	ABE7CPA31	0.498/ 1.098
	BMXAMI0810		Spring	ABE7CPA31E	0.508/ 1.120
Preassembled cordsets for Modicon Telefast ABE7 sub-bases	BMXAMI0410	One 20-way removable terminal block and one 25-way SUB-D connector for ABE7CPA410/CPA21 sub-base	1.5 m/4.92 ft	BMXFCA150	0.320/ 0.705
	BMXAMO0210		3 m/9.84 ft	BMXFCA300	0.500/ 1.102
	BMXAMO0410		5 m/16.4 ft	BMXFCA500	0.730/ 1.609
	BMXART0414	One 40-way connector and one 25-way SUB-D connector for ABE7CPA412 sub-base	1.5 m/4.92 ft	BMXFCA152	0.330/ 0.728
	BMXART0814 (2)		3 m/9.84 ft	BMXFCA302	0.510/ 1.124
			5 m/16.4 ft	BMXFCA502	0.740/ 1.631
	BMXAMI0800	One 28-way removable terminal block and one 25-way SUB-D connector for sub-bases ABE7CPA02/03/31/31E	1.5 m/4.92 ft	BMXFCA150	0.374/ 0.825
	BMXAMI0810		3 m/9.84 ft	BMXFCA300	0.500/ 1.102
	BMXAMO0802	One 20-way removable terminal block and one 25-way SUB-D connector for ABE7CPA02 sub-bases	1.5 m/4.92 ft	BMXFCA152	0.374/ 0.825
			3 m/9.84 ft	BMXFCA302	0.500/ 1.102

(1) The shielding on the cordsets carrying the analog signals must always be connected to the BMXXSP●●00 shielding connection kit mounted under the rack holding the analog modules (see page 2/3).

(2) The BMXART0814 8-channel module requires two ABE7CPA412 sub-bases and two BMXFCA●●2 cordsets.

# Modicon X80 module platform

X80 I/O modules  
HART analog I/O modules

Applications		HART analog inputs	HART analog outputs
			
<b>Type of I/O</b>		Isolated analog inputs with HART	Isolated analog outputs with HART
<b>Number of channels</b>		8	4
<b>Range</b>	Current	4-20 mA	
<b>Maximum load impedance</b>		–	600 Ω (0-20 mA)
<b>Operating temperature</b>		0...60°C/32...140°F	
<b>Dimensions</b>	W x H x D	32 x 100 x 86 mm/1.25 x 3.93 x 3.38 in.	
<b>Compatible devices</b>		<b>BMEP58●●●●</b> processors <b>BMECRA31210</b> drop module <b>BMEXBP●●00(H)</b> Ethernet + X-bus backplanes <b>140NOC78000</b> Quantum Ethernet DIO module	<b>BMEP58●●●●</b> processors <b>BMECRA31210</b> drop module <b>BMEXBP●●00(H)</b> Ethernet + X-bus backplanes <b>140NOC78000</b> Quantum Ethernet DIO module
<b>Resolution</b>		15 bits + sign	
<b>Isolation</b>	Between channels	1000 V ~ for 1 minute	
	Between channels and bus	1400 V ~ for 1 minute	
	Between channels and ground	1400 V ~ for 1 minute	
<b>Connection</b>	Directly to the module	Via <b>BMXFTB20●0</b> 20-way caged, screw clamp, or spring-type removable terminal block	
<b>Compatibility with Modicon Telefast ABE7 pre-wired system</b>	Connection sub-base	8-channel sub-base for direct connection of 8 current/voltage inputs	4-channel sub-base for direct connection of 2/4 current/voltage outputs
	Type of connection sub-base	<b>ABE7CPA02, ABE7CPA03, ABE7CPA31</b>	<b>ABE7CPA21</b>
	Type of preassembled cordsets	<b>BMXFCA1522, BMXFCA3022</b> (1,5 or 3 m/4.92 or 9.84 ft)	<b>BMXFCA150, BMXFCA300, BMXFCA500</b> (1,5, 3, or 5 m/4.92, 9.84, or 16.4 ft)
<b>Field device support</b>		2-wire/4-wire	
<b>HART specification</b>	HART field device compliance	HART V5, V6, V7	
	HART field device connection	Point-to-point	
	HART I/O mapping	Yes	
<b>References</b>	<b>BMEAHI0812</b>	<b>BMEAHO0412</b>	
<b>Page</b>	4/29	4/29	

4

4



More technical information on [www.se.com](http://www.se.com)



More technical information on [www.se.com](http://www.se.com)

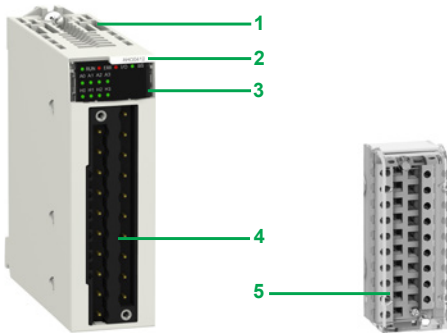

Module for connection via 20-way removable terminal block



DIA6ED2151012EN



BMXFTW01S



BMXFCA000

#### Presentation

**BMEAH0012** HART analog I/O modules contain transceivers that control HART devices and information through the module. They can be managed by the AMS (Asset Management System) or by the automation platform CPU.

These modules require an Ethernet + X-bus backplane and can only be installed in the main local rack with the CPU or in RIO drops with a **BMECRA31210** X80 Remote I/O drop performance adapter. They cannot be installed in expansion racks.

#### Description

**BMEAH0012** HART analog I/O modules are standard format (1 slot). They have a case, which provides IP20 protection of the electronics, and are locked into position by a captive screw. They are connected via a 20-way removable terminal block.

**BMEAH0012** HART analog I/O modules feature the following:

- 1 A rigid body providing support and protection for the electronic card
- 2 A module reference marking (a label is also visible on the right-hand side of the module)
- 3 A module and channel status display block
- 4 A connector taking the 20-way removable screw clamp or spring-type terminal block for directly connecting the sensors or preactuators to the module

To be ordered separately (see [page 4/25](#)):

- 5 A **BMXFTB2000** 20-way removable terminal block (referencing label supplied with each I/O module) or pre-wired cables with:
  - A 20-way terminal block at one end and flying leads at the other (**BMXFTW01S**)
  - A 20-way terminal block and a 25-way SUB-D connector (**BMXFCA000** or **BMXFTA0022**), for connection to Modicon Telefast ABE 7 sub-bases

#### Connecting modules using 20-way removable terminal blocks

The 20-way removable terminal blocks (**BMXFTB2000**) are the same as those used for discrete I/O modules (screw clamp, caged or spring-type) (see [page 4/25](#)).

One version of the removable terminal block is equipped with a 3 or 5 m/9.84 or 16.4 ft cordset with color-coded flying leads (**BMXFTW01S**). These preassembled cordsets with reinforced shielding have color-coded flying leads at the other end.

#### Use with Modicon Telefast ABE7 sub-bases

##### Modicon Telefast ABE7CPA21 sub-base

The Modicon Telefast **ABE7CPA21** sub-base is compatible with the **BMEAH00412** output module.

This sub-base allows you to:

- Directly connect two current/voltage outputs
- Ensure continuity of the shielding

Connection is via the **BMXFCA000** cordset (1.5, 3, or 5 m/4.92, 9.84, or 16.4 ft long).

##### Modicon Telefast ABE7CPA02 sub-base

The Modicon Telefast **ABE7CPA02** sub-base can be used with the **BMEAH10812** HART analog input module.

This sub-base allows you to:

- Connect the 8 analog inputs point-to-point
- Ensure continuity of the shielding

The **BMEAH10812** module is connected by means of the 1.5 or 3 m/4.92 or 9.84 ft long **BMXF1A1522/3022** cables.



DIA3ED2160602EN

#### Use with Modicon Telefast ABE7 sub-bases

##### Modicon Telefast ABE7CPA03 sub-base

The Modicon Telefast **ABE7CPA03** sub-base can be used with the **BMEAHI0812** HART analog input module.

This sub-base allows you to:

- Directly connect the 8 analog inputs
- Power the current inputs one channel at a time with a voltage of 24 V that is protected and limited to 25 mA
- Ensure continuity of the shielding

The **BMEAHI0812** module is connected by means of the 1.5 or 3 m/4.92 or 9.84 ft long **BMXFTA1522/3022** cables (1).

##### Modicon Telefast ABE7CPA31 sub-base

The Modicon Telefast **ABE7CPA31** sub-base can be used with the **BMEAHI0812** HART analog input module.

This sub-base allows you to:

- Directly connect the 8 analog inputs
- Power the current inputs one channel at a time with 24 V converters
- Ensure continuity of the shielding

The **BMEAHI0812** module is connected by means of the 1.5 or 3 m/4.92 or 9.84 ft long **BMXFTA1522/3022** cables.

#### Additional characteristics

##### BMEAHI0812 HART analog input module

The **BMEAHI0812** module is a module with 8 high-level isolated inputs (15 bits + sign).

The **BMEAHI0812** module offers the current range 4 - 20 mA for each of the inputs depending on the choice made during configuration.

##### BMEAHO0412 HART analog output module

The **BMEAHO0412** module is a module with 4 high-level isolated outputs (15 bits + sign).

The **BMEAHO0412** module offers the current range 4 - 20 mA for each of the inputs depending on the choice made during configuration.

#### References

##### X80 HART analog input module

Type of input	Input signal range	Resolution	Connection via	No. of channels	Reference	Weight kg/lb
Isolated high-level inputs	4 - 20 mA	15 bits + sign	20-way caged, screw clamp, or spring-type removable terminal block	8 channels	<a href="#">BMEAHI0812</a>	0.233/ 0.514

##### X80 HART analog output module

Type of input	Output signal range	Resolution	Connection via	No. of channels	Reference	Weight kg/lb
Isolated high-level outputs	4 - 20 mA	15 bits + sign	20-way caged, screw clamp, or spring-type removable terminal block	4 channels	<a href="#">BMEAHO0412</a>	0.223/ 0.492



BMEAHI0812

(1) The **BMEAHI0812** HART analog input module loses its isolation between channels when connected to the Modicon Telefast **ABE7CPA03** sub-base.



---

## Modicon X80 Safety products

*Modicon Safety selection guide* ..... page 5/2

■ Safety Product compatibility ..... page 5/4

## X80 Safety power supplies

■ Presentation, description ..... page 5/6

■ Functions, references ..... page 5/7

## X80 Safety discrete I/O modules

■ Presentation..... page 5/8

■ Description, connections ..... page 5/9

■ References ..... page 5/10

## X80 Safety analog I/O module

■ Presentation, description, connections ..... page 5/11

■ References ..... page 5/11

# Modicon X80 module platform

X80 Safety  
Safety I/O modules

Applications	16-channel Safety discrete input module	8-channel Safety discrete output module	4-channel Safety relay output module	4-channel Safety analog input module
--------------	---	---	--------------------------------------	--------------------------------------



Type	---		~/ --- relays	Current
Voltage	24 V		24 V ---/24...230 V ~	—
Current per channel	3.5 mA	0.5 A	5 A	—
Range	Voltage		—	6
	Current		—	4...20 mA
Modularity	Number of channels		16	8
	Number of groups		2: 0...3 (banks A & B) and 4...7 (banks A & B)	1
	Number of channels per common		8	—
Acquisition period	Hot-swap RAID HDD and battery backup		—	5 ms for the 4 inputs
Resolution	—		—	16 bits (12,500 counts)
Connection	Via <b>BMXFTB20●0</b> 20-way caged, screw clamp, or spring-type removable terminal block			
Isolated inputs	IEC/EN 61131-2 conformity		Type 3	—
	Logic		Positive	—
	Type of input		—	Resistive
	Sensor compatibility IEC/EN 60947-5-2		2-wire/3-wire	—
Isolated outputs	Fallback		—	Configurable fallback setting for each channel
	IEC/EN 61131-2 conformity		—	Yes
	Protection		—	Yes
	Logic		—	Positive
Isolation	Between channels		Non-isolated	3000 Vrms
	Between channels and bus		1500 Vrms	3000 Vrms
	Between channels and ground		1500 Vrms	3000 Vrms
Dimension	W x H x D			
Sensor power supply (ripple included)	19...30 V		—	—
Preactuator power supply (ripple included)	—		19...30 V	10...264 V ~/10...34 V ---
Protection of inputs	Use a fast-blow fuse, max 0.5 A, depending on the module current load		—	—
Output fuse protection	—		Use a fast-blow fuse, max 6 A, depending on the module current load	Use a fast-blow fuse, max 6 A, depending on the relay contact current load
Maximum dissipated power	3.57 W		4.40 W	3.90 W
Conformal coated	Yes			
Operating temperature	-25...60 °C/-13...140 °F			
References	<b>BMXSDI1602</b>	<b>BMXSDO0802</b>	<b>BMXSRA0405</b>	<b>BMXSAI0410</b>
Page	5/10			5/11

5

5



More technical information on [www.se.com](http://www.se.com)



More technical information on [www.se.com](http://www.se.com)



# Modicon M580/X80 platforms

## Safety product compatibility according to network architecture and platform

For non safety product compatibility, please refer to [page 1/8](#)

Product type	Commercial reference (1)	Module type	M580 Safety					
			Local rack with Safety CPU and coprocessor (X-bus + Ethernet rack BMEXBP are mandatory for Safety CPU and coprocessor)		X80 drops on Ethernet Remote I/O		X80 drops on distributed I/O	
			Standalone	Redundant (HSBY)	Standalone or redundant (HSBY)		Standalone	
			X-bus + Ethernet rack BMEXBP●●●●		X-bus rack BMXXBP●●●●		X-bus + Ethernet rack BMEXBP●●●●	X-bus rack BMXXBP●●●●
				BMXCRA31200	BMXCRA31210	BMECRA31210	BMXPRA0100	
Safety power supplies	BMXCPS4002S	Redundant safety power supply						
	BMXCPS4022S	Redundant safety power supply						
	BMXCPS3522S	Redundant safety power supply						
Backplanes	BMXXBP0400 (H)	X-bus backplane						
	BMXXBP0600 (H)	X-bus backplane						
	BMXXBP0800 (H)	X-bus backplane						
	BMXXBP1200 (H)	X-bus backplane						
	BMXXBE1000 (H) (2)	X-bus rack expansion module						
	BMXXBE2005 (3)	X-bus rack expansion kit						
	BMEXBP0400 (H)	X-bus+Eth backplane						
	BMEXBP0800 (H)	X-bus+Eth backplane						
	BMEXBP1200 (H)	X-bus+Eth backplane						
	BMEXBP0602 (H) (4)	X-bus+Eth dual power supplies backplane						
	BMEXBP1002 (H) (4)	X-bus+Eth dual power supplies backplane						
	BMXXEM010 (5)	Protective cover connector						
	Safety I/O	BMXSAI0410	Safety analog input					
BMXSDI1602		Safety discrete input						
BMXSDO0802		Safety discrete output						
BMXSRA0405		Safety relay output						
I/O expansion	BMXCRA31200	RIO drop X-bus adapter						
	BMXCRA31210 (C)	RIO drop X-bus adapter						
	BMECRA31210 (C)	RIO drop X-bus+Eth adapter						
	BMXPRA0100	DIO drop adapter						

(1) Optional versions: (C) - "Coated", (H) - "Hardened"  
 (2) Extended rack can be any type of rack, but only X-bus modules (BMX) can be used  
 (3) Extended rack kit  
 (4) Not compatible with single power supplies  
 (5) Protective cover for all X-bus or Eth bus connectors

Compatible  Not compatible

Note: All X80 Safety modules are compatible with the Modicon M580 Safety ePAC only.

#### Presentation

The Safety power supply in the Modicon X80 module platform offer is the **BMXCPS●●●2S**.

The **BMXCPS4022S** Safety power supply:

- Converts 24...48 V  $\overline{\text{---}}$  power into two output voltages, 24 V  $\overline{\text{---}}$  and 3.3 V  $\overline{\text{---}}$ , which are distributed over the backplane
- Detects overvoltage, overload, and short-circuit conditions on both the 3.3 V  $\overline{\text{---}}$  and 24 V  $\overline{\text{---}}$  backplane lines

The **BMXCPS3522S** Safety power supply:

- Converts 100...150 V  $\overline{\text{---}}$  power into two output voltages, 24 V  $\overline{\text{---}}$  and 3.3 V  $\overline{\text{---}}$ , which are distributed over the backplane
- Detects overvoltage, overload, and short-circuit conditions on both the 3.3 V  $\overline{\text{---}}$  and 24 V  $\overline{\text{---}}$  backplane lines

The **BMXCPS4002S** Safety power supply:

- Converts 110...240 V  $\sim$  power into two output voltages, 24 V  $\overline{\text{---}}$  and 3.3 V  $\overline{\text{---}}$ , which are distributed over the backplane
- Detects overvoltage, overload, and short-circuit conditions on both the 3.3 V  $\overline{\text{---}}$  and 24 V  $\overline{\text{---}}$  backplane lines, and allows a maximum voltage of 30 V  $\overline{\text{---}}$

#### Description

The **BMXCPS●●●2S** Safety power supply includes:

- 1 Display panel comprising LEDs with various combinations to provide quick diagnostics of the power supply status:
  - ACTIVE LED (green): On when the power supply is the master power supply, off when it acts as a slave supply in a redundant application
  - OK LED (green): On if the rack voltages are present and correct
  - RD LED (green): On when all the internal power supplies function normally
- 2 Printed serial number and product version
- 3 Pencil-point Reset pushbutton for a cold restart of the application
- 4 2-way connector that can take a removable terminal block (caged or spring-type) for connecting the alarm relay
- 5 A 5-way connector that can take a removable terminal block (caged or spring-type) for connecting the following:
  - AC or DC line supply
  - Protective ground
- 6 1 hook and 1 screw for mechanical attachment and grounding connection to the backplane

**Included with each power supply:** Set of two caged removable terminal blocks (5-way and 2-way) **BMXXTSCPS10**

**To be ordered separately (if necessary):** Set of two spring-type removable terminal blocks (5-way and 2-way) **BMXXTSCPS20** (see [page 5/7](#)).

#### Compatibility of the power supply with the rack

The **BMXCPS●●●2S** is a safety-certified power supply that can be used as:

- a main local rack
- an extended local rack
- a main remote rack
- an extended remote rack

The **BMXCPS●●●2S** is a redundant power supply. It can be installed alone in single power supply rack or dual power supply rack as a pair (master and slave).

For high-availability applications, two independent redundant power supplies can be used to increase the security of the power supply. In case the master power supply fails to provide the whole current, the slave power supply changes to master mode and continues to function.

The power supply has to be inserted in the leftmost power supply slots on each rack (marked CPS).

#### Advanced diagnostics

The **BMXCPS●●●2S** can provide advanced diagnostics such as current load, temperatures, remaining life time, and undervoltage thresholds. These unique values will help to simplify maintenance by predicting when to replace the power supply before it fails.

**Note:** LED diagnostic display is provided for the module and for each input channel.

M1890\_62018\_CPSCT16005C

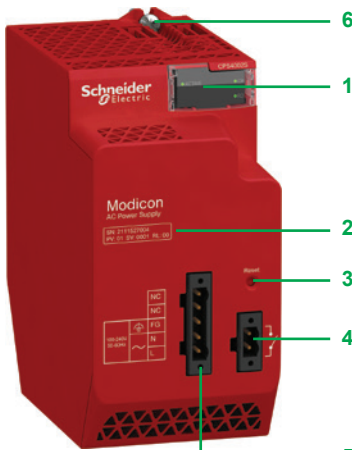

BMXCPS●●●2S

#### Functions

##### Alarm relay

The alarm relay incorporated in each power supply has a volt-free contact accessible on the front panel, on the 2-way connector.

The operating principle is as follows:

- The alarm relay is energized and its contact is closed (state 1) in normal operation, with the PLC in RUN.
- The relay de-energizes and its associated contact opens (state 0) whenever the application stops, even partially, due to any of the following:
  - Occurrence of a blocking fault (RAM detected error in memory check, Safety watchdog overrun detected on CPU, etc.)
  - Incorrect rack output voltages
  - Loss of supply voltage

##### Reset pushbutton

The power supply in each rack has a Reset button on the front panel.

Pressing the Reset button on the power supply causes re-initialization of all modules in the same rack as the power supply. If the **BMXCPS●●●2S** power supply is in the main local rack, pressing the Reset button causes re-initialization of the CPU.

In a redundant design, with two **BMXCPS●●●2S** power supplies, you can press the Reset button on either, or both, power supplies to execute the reset function.

Pressing this pushbutton triggers a sequence of service signals, which is the same as that for:

- A power break, when the pushbutton is pressed.
- A power-up, when the pushbutton is released

In terms of the application, these operations represent a cold start (forcing the I/O modules to state 0 and initializing the processor).

#### References

##### X80 Safety power supply (1)

Line supply	Available power (2)			Nominal current	Reference	Weight kg/lb
	3.3 V $\overline{\text{---}}$ (3)	24 V $\overline{\text{---}}$ rack (3)	Total			
24...48 V $\overline{\text{---}}$	18 W	40 W	40 W	1.67 A	<a href="#">BMXCPS4022S</a>	0.810/ 1.786
100...150 V $\overline{\text{---}}$	180 W	40 W	40 W	1.67 A	<a href="#">BMXCPS3522S</a>	0.610/ 1.345
100...240 V $\overline{\text{---}}$	18 W	40 W	40 W	1.67 A	<a href="#">BMXCPS4002S</a>	0.510/ 1.124

##### Accessories for X80 Safety power supply

Description	Type	Composition	Reference	Weight kg/lb
Removable connectors	Spring-type	One 5-way terminal block and one 2-way terminal block	<a href="#">BMXXTSCPS20</a>	0.015/ 0.033
	Caged	One 5-way terminal block and one 2-way terminal block	<a href="#">BMXXTSCPS10</a>	0.020/ 0.044

(1) Include a set of 2 caged removable connectors. Spring-type connectors available separately under reference [BMXXTSCPS20](#).

(2) The sum of the power consumed on each voltage (3.3 V  $\overline{\text{---}}$  and 24 V  $\overline{\text{---}}$ ) must not exceed the total power of the module. See the power consumption table available on our website [www.se.com](http://www.se.com).

(3) 3.3 V  $\overline{\text{---}}$  and 24 V  $\overline{\text{---}}$  rack voltages for powering modules in the Modicon X80 I/O rack.

M580\_62098\_SFSCT17005



Modicon M580 Safety configuration with a mix of standard X80 and Safety I/O

M580\_62098\_SFSCT17008



Modicon Safety configuration with Safety X80 modules only with removable terminal blocks

#### Presentation of Safety I/O modules

X80 is a powerful, proven solution for integrating an homogeneous automation architecture with a unique process and safety platform.

In the Modicon X80 offer, a Safety project can include both Safety modules and non-safety modules:

- Safety modules in the SAFE task
- Non-safety modules only for the non-safety tasks (MAST, FAST, AUX0, and AUX1)

Only non-safety modules that do not interfere with the safety function can be added to a Safety project.

Safety I/O modules can be used to connect the Safety PAC to sensors and actuators that are not part of the safety function loop.

Each Safety I/O module incorporates a dedicated Safety processor.

Safety I/O modules can be installed in the local backplane or in RIO drops.

All Safety I/O modules support SIL3 standards according to IEC 61508. The assessment is indicated by the category (Cat) and performance level (PL).

Each Safety I/O module provides module and channel LED diagnostics on the front face of the module:

- The top four LEDs (Run, Err, I/O, and Lck) indicate the module status.
- The bottom rows of LEDs combine with the top four LEDs to indicate the state and health of each input or output channel.

#### Presentation of Safety discrete I/O modules

There are three Safety discrete I/O modules in the Modicon X80 offer:

- **BMXSDI1602** Safety discrete input module
- **BMXSDO0802** Safety discrete output module
- **BMXSRA0405** Safety discrete relay output module

These modules can only be used with a Safety CPU.

##### BMXSDI1602

The **BMXSDI1602** Safety discrete input module has the following features:

- 16 Type 3 (1) inputs, in two groups of 8 non-isolated inputs
- 24 V  $\overline{\text{---}}$  nominal input voltage
- Achieves SIL3, Cat2/PLd assessment using 1 input channel and Cat4/PLe using 2 input channels
- Compatible with 2- or 3-wire proximity sensors
- Optional provision of two 24 V  $\overline{\text{---}}$  outputs (VS1 and VS2) for short-circuit to 24 V  $\overline{\text{---}}$  monitoring
- Monitoring of external 24 V  $\overline{\text{---}}$  sensor supply voltage

##### BMXSDO0802

The **BMXSDO0802** Safety discrete output module has the following features:

- 8 non-isolated 0.5 A outputs
- 24 V  $\overline{\text{---}}$  nominal output voltage
- Achieves SIL3, Cat4/PLe assessment
- Monitoring of the external pre-actuator power supply

##### BMXSRA0405

The **BMXSRA0405** Safety discrete relay output module has the following features:

- 4 relay outputs with 5 A current
- 24 V  $\overline{\text{---}}$  and 24...230 V  $\sim$  nominal output voltage (overvoltage category II)
- Achieves SIL2, Cat2/PLc assessment using 1 relay and SIL3, Cat4/PLe using 2 relays
- Support for 8 pre-defined application wiring configuration selections
- Configurable automatic self-test monitoring of the relay capacity to execute the commanded output state (depending on the selected application wiring configuration)
- Configurable module settings for fallback mode and fallback timeout (in ms)

(1) According to IEC61131-2 standard

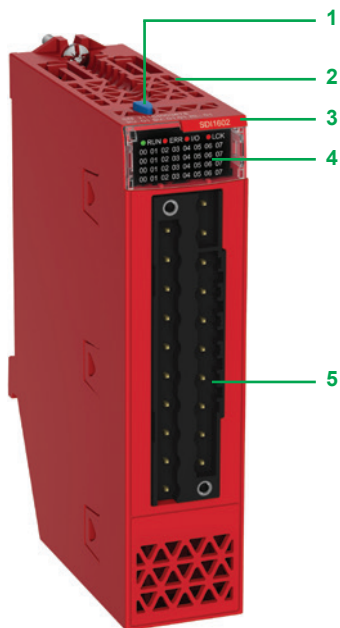

Safety discrete I/O module

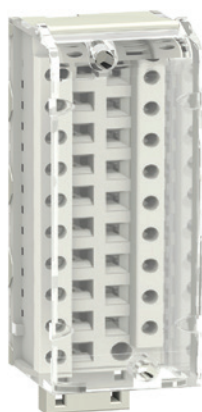

BMXFTB2000

#### Description

Safety discrete I/O modules are standard format with one slot. They have an IP20 housing to help protect the electronics, and are locked into position with a captive screw.

To be ordered separately: A **BMXFTB2000** 20-way removable terminal block (identification label supplied with each I/O module) or a preassembled cordset with a 20-way removable terminal block at one end and flying leads at the other (see connections on [page 5/9](#)):

**BMXSDI1602**, **BMXSDO0802**, and **BMXSRA0405**, Safety discrete modules include:

- 1 Lock/unlock configuration button
- 2 Rigid body providing support and protection for the electronic card
- 3 Module reference marking (a label is also visible on the right-hand side of the module)
- 4 Display panel comprising LEDs with various combinations to provide quick diagnostics of the status of the module and each channel:
  - RUN LED (green): module in operation
  - ERR LED (red): detected module error
  - I/O LED (red): detected I/O error
  - LCK LED (bi-color green/red): indicates the configuration status
  - 1 LED per channel (bi-color green/red): indicates the channel status
- 5 Connector taking the 20-way removable terminal block for connecting sensors or preactuators

#### Connections

20-way removable terminal blocks are used to connect the three Safety discrete I/O modules.

There are three types of 20-way removable terminal block:

- caged terminal block **BMXFTB2000** (1)
- screw clamp terminal block **BMXFTB2010** (1)
- spring-type terminal block **BMXFTB2020** (1)

Type of terminal block	Minimum capacity	Maximum capacity
Caged (1)	One 0.34 mm <sup>2</sup> wire (AWG 22)	One 1 mm <sup>2</sup> wire (AWG 18)
Screw clamp (1)	One or two 0.34 mm <sup>2</sup> wires (AWG 22)	Two 1.5 mm <sup>2</sup> wires (AWG 15)
Spring-type	One 0.34 mm <sup>2</sup> wire (AWG 22)	One 1 mm <sup>2</sup> wire (AWG 18)

(1) Connectors are equipped with captive screws: max. tightening torque 0.5 N.m/0.37 lb-ft.

**Note:** No cordset is provided for cabling Safety X80 I/O modules. Too many options are possible according to the kind of:

- application: safety only, safety mixed with availability, etc.
- functional safety level: SIL3/Cat2, SIL3/Cat4, SIL2, etc.

For more information on the different cabling options, please refer to the detailed user manuals published on our website: [www.se.com](http://www.se.com).

# Modicon X80 module platform

## X80 Safety

### Safety discrete I/O modules

M590\_62098\_CP5CT16001D



BMXSDI1602

M590\_62098\_CP5CT16002A



BMXSDO0802

M590\_62098\_CP5CT16004A



BMXSRA0405

5

#### References

##### X80 Safety discrete input module

Type of current	Input voltage	Connection via	IEC/EN 61131-2 conformity	Number of channels (common)	Reference	Weight kg/lb
DC	24 V (logic positive)	20-way caged, screw clamp, or spring-type removable terminal block	Type 3	16 non-isolated inputs (1 x 16)	<a href="#">BMXSDI1602</a>	0.115/ 0.254

##### X80 Safety discrete output module

Type of current	Input voltage	Connection via	IEC/EN 61131-2 conformity	Number of channels (common)	Reference	Weight kg/lb
DC	24 V (logic positive)	20-way caged, screw clamp, or spring-type removable terminal block	Yes	8 non-isolated outputs (1 x 8)	<a href="#">BMXSDO0802</a>	0.120/ 0.264

##### X80 Safety relay output module

Type of current	Input voltage	Connection via	IEC/EN 61131-2 conformity	Number of channels (common)	Reference	Weight kg/lb
AC/DC relay	24 V $\overline{\text{---}}$ / 24...230 V $\sim$	20-way caged, screw clamp, or spring-type removable terminal block	Yes	4 isolated outputs (1 x 4)	<a href="#">BMXSRA0405</a>	0.145/ 0.320

##### Removable terminal blocks

Description	For use with modules	Type composition	Reference	Weight kg/lb
20-way removable terminal blocks	BMXSDI1602	Caged	<a href="#">BMXFTB2000</a>	0.093/ 0.205
	BMXSDO0802	Screw clamp	<a href="#">BMXFTB2010</a>	0.075/ 0.165
	BMXSRA0405	Spring	<a href="#">BMXFTB2020</a>	0.062/ 0.132

M580\_62098\_CPSCT16001D

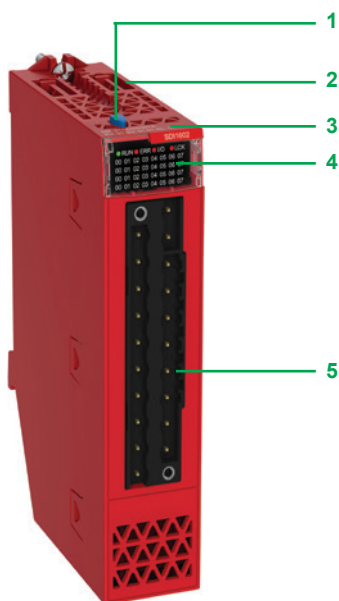

BMXSAI0410

#### Presentation

The Safety analog input module in the Modicon X80 offer is the **BMXSAI0410**, which has the following features:

- 4 isolated analog 4...20 mA current input channels
- 16-bit resolution (12,500 counts), spanning the data range 0...25 mA
- Current out of range detection, for current values less than 3.75 mA or greater than 20.75 mA
- Achieves SIL3, Cat2/PLd assessment using 1 input channel and SIL3, Cat4/PLe using 2 input channels

This module can only be used with a Safety CPU.

#### Description

The **BMXSAI0410** Safety analog input module includes:

- 1 Lock/unlock configuration button
- 2 Rigid body providing support and protection for the electronic card
- 3 Module reference marking (a label is also visible on the right-hand side of the module)
- 4 Display panel comprising LEDs with various combinations to provide quick diagnostics of the status of the module and each channel (1):
  - RUN LED (green): module in operation
  - ERR LED (red): detected module error
  - I/O LED (red): detected I/O error
  - LCK LED (bi-color green/red): indicates the configuration status
  - 1 LED per channel (bi-color green/red): indicates the channel status
- 5 Connector taking the 20-way removable terminal block for connecting sensors or preactuators

#### Connections

20-way removable terminal blocks are used to connect the analog input module. (2)

There are three types of 20-way removable terminal block:

- caged terminal block **BMXFTB2000** (3)
- screw clamp terminal block **BMXFTB2010** (3)
- spring-type terminal block **BMXFTB2020**

Type of terminal block	Minimum capacity	Maximum capacity
Caged (3)	One 0.34 mm <sup>2</sup> wire (AWG 22)	One 1 mm <sup>2</sup> wire (AWG 18)
Screw clamp (3)	One or two 0.34 mm <sup>2</sup> wires (AWG 22)	Two 1.5 mm <sup>2</sup> wires (AWG 15)
Spring-type	One 0.34 mm <sup>2</sup> wire (AWG 22)	One 1 mm <sup>2</sup> wire (AWG 18)

Red labels are provided for Safety I/O modules.

#### References

##### X80 Safety analog input modules

Type of input	Input signal range	Resolution	Connection	Nb of channels	Reference	Weight kg/lb
Isolated high-level input	4–20 mA	16 bits	20-way caged, screw clamp, or spring-type removable terminal block	4	<a href="#">BMXSAI0410</a>	0.143/ 0.315

##### Connection accessories for X80 Safety analog input module

Description	For use with modules	Type composition	Reference	Weight kg/lb
20-way removable terminal blocks	BMXSAI0410	Caged	<a href="#">BMXFTB2000</a>	0.093/ 0.205
		Screw clamp	<a href="#">BMXFTB2010</a>	0.075/ 0.165
		Spring	<a href="#">BMXFTB2020</a>	0.060/ 0.132

(1) LEDs in positions 5...7 are not used because the input module only has four channels.

(2) No cordset is provided for cabling safety X80 I/O modules. Too many options are possible according to the kind of:

- applications: safety only, safety mixed with availability, etc.
- functional safety level: SIL3/Cat2, SIL3/Cat4, SIL2, etc.

For more information on the different cabling options, please refer to the detailed user manuals published on our website: [www.se.com](http://www.se.com).

(3) Connectors are equipped with captive screws: max. tightening torque 0.5 N.m/0.37 lb-ft.

M580\_62098\_OPEJFR17001A



SDI1602 red label

PF108141D

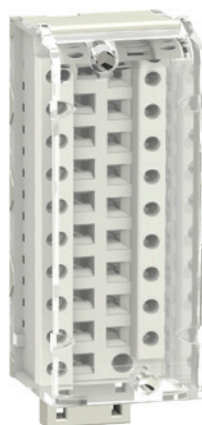

BMXFTB2000





---

## X80 Counter modules

- Presentation, description ..... [page 6/2](#)
- Functions ..... [page 6/3](#)
- References ..... [page 6/5](#)

## X80 Time-stamping module

- Presentation, description ..... [page 6/6](#)
- Performance, references ..... [page 6/7](#)

## X80 SSI encoder interface module

- Presentation, description ..... [page 6/8](#)
- Functions, references ..... [page 6/9](#)

## X80 Motion control module

- Presentation, description ..... [page 6/10](#)
- Operation, references ..... [page 6/11](#)
- MFB library presentation, functions ..... [page 6/12](#)
- Motion tree manager, programming, maintenance ..... [page 6/13](#)

## X80 Frequency input module

- Presentation, description ..... [page 6/14](#)
- Module specifications, references ..... [page 6/15](#)

## X80 Weighing module

- Presentation, description ..... [page 6/16](#)
- References ..... [page 6/17](#)

#### Presentation

**BMXEHC0200** and **BMXEHC0800** counter modules for the Modicon X80 module platform are used to count the pulses generated by a sensor or to process the signals from an incremental encoder.

The two modules differ in their number of counter channels, maximum input frequencies, functions, and auxiliary input and output interfaces:

Counter module	No. of channels	Maximum frequency	Integrated functions	No. of physical inputs	No. of physical outputs
<b>BMXEHC0200</b>	2	60 KHz	Upcounting Downcounting Period meter Frequency meter Frequency generator Axis control	6	2
<b>BMXEHC0800</b>	8	10 KHz	Upcounting Downcounting Measurement	2	–

The sensors used on each channel can be:

- 2-wire 24 V proximity sensors
- 3-wire 24 V proximity sensors
- 10/30 V output signal incremental encoders with push-pull outputs

**BMXEHC0200/0800** counter modules can be used to meet the demands of applications such as:

- Alarm generation on empty unwinder status using the ratio
- Sorting small parts using the period meter
- Single electronic cam using the dynamic setting thresholds
- Speed control using the period meter

These standard format modules can be installed in any available slot on a Modicon X80 platform. They are hot-swappable.

In a Modicon X80 PLC configuration, the number of **BMXEHC0200/0800** counter modules should be added to the number of application-specific modules (communication). The function parameters are set by configuration using EcoStruxure Control Expert (1) software.

#### Description

**BMXEHC0200/0800** counter modules are standard format. They occupy a single slot in **BM●XBP●●●** racks. They come in a plastic case, which provides IP20 protection of the electronics, and are locked into position by a captive screw.

#### BMXEHC0200 module, 2 channels, 60 KHz

The front panel of the **BMXEHC0200** counter module features:

- 1 Module and channel status display block
- 2 16-way connector for connecting the sensors of counter 0
- 3 16-way connector for connecting the sensors of counter 1
- 4 10-way connector for connecting:
  - Auxiliary outputs
  - Sensor power supplies

**To be ordered separately:**

- A **BMXXTSHSC20** kit containing two 16-way connectors and one 10-way connector (see [page 6/5](#))
- A **BMXXSP●●00** shielding connection kit if the rack is not already equipped with one (see [page 2/5](#))

#### BMXEHC0800 module, 8 channels, 10 KHz

The front panel of the **BMXEHC0800** counter module features:

- 1 Module and channel status display block
- 2 Connector taking the **BMXFTB20●0** 20-way removable terminal block 3 (same as that of I/O modules)

**To be ordered separately:**

- A 20-way removable terminal block 3 (caged, screw clamp, or spring-type) (see [page 4/15](#))
- A **BMXXSP●●00** shielding connection kit if the rack is not already equipped with one (see [page 2/5](#))

(1) EcoStruxure Control Expert software continues the Unity Pro range of software and corresponds to versions ≥ 14 of Unity Pro.



EcoStruxure Control Expert monitor

6

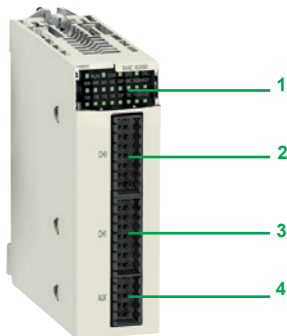

BMXEHC0200

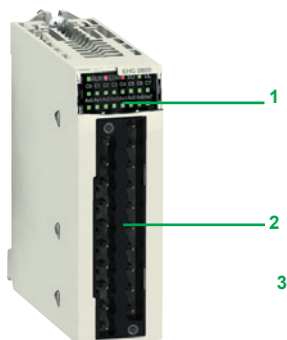

BMXEHC0800

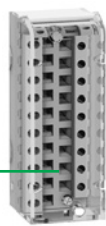

BMXFTB20●0

#### Operating modes for module BMXEHC0200

8 configurable modes	
Frequency meter	<p>This mode measures a frequency, speed, data rate, or an event stream. As standard, this mode measures the frequency received on the IN_A input. This frequency is expressed in Hz (number of pulses/second), with a precision of 1 Hz.</p> <p>The maximum frequency on the IN_A input is 60 kHz. The maximum cyclic ratio at 60 kHz is 60%.</p>
Event counting	<p>This mode is used to determine the number of events received. In this mode, the counter calculates the number of pulses applied to the IN_A input at time intervals defined by the user.</p> <p>The module counts the pulses applied to the IN_A input each time the pulse for this input lasts longer than 5 μs (without anti-bounce filter).</p>
Period measurement	<p>This mode is used to:</p> <ul style="list-style-type: none"> <li>■ Determine the duration of an event</li> <li>■ Determine the time between 2 events</li> <li>■ Time and measure the execution time of a process</li> </ul> <p>It measures the time elapsed during an event or between 2 events (IN_A input) according to a selectable time base of 1 μs, 100 μs, or 1 ms. The IN_SYNC input can be used to enable or stop a measurement. The module can carry out a maximum of 1 measurement every 5 ms. The shortest measurable pulse is 100 μs, even if the unit defined by the user is 1 μs. The maximum measurable duration is 4,294,967,295 units (unit to be defined).</p>
Ratio counting	<p>Ratio counting mode only uses the IN_A and IN_B inputs. There are 2 possible modes:</p> <ul style="list-style-type: none"> <li>■ Ratio 1: Used to divide 2 frequencies. This is intended for applications such as flowmeters, mixers, etc.</li> <li>■ Ratio 2: Used to subtract 2 frequencies. This is intended for the same applications, but for those requiring more precise regulation (more similar frequencies).</li> </ul> <p>Ratio 1 mode gives the results in thousandths for better accuracy (a display of 2,000 corresponds to a value of 2) and ratio 2 mode gives the results in Hz.</p> <p>The maximum frequency that the module can measure on the IN_A and IN_B inputs is 60 kHz.</p>
Downcounting	<p>This mode is used to list a group of operations. In this mode, activating the synchronization function starts the counter which, starting from a user-defined preset value, decreases with each pulse applied to the IN_A input, until it reaches 0. This downcounting is made possible when the enable function has been activated. The counting register is thus updated at 1 ms intervals.</p> <p>One basic use of this mode is to signal, using an output, the end of a group of operations (when the counter reaches 0).</p> <p>The shortest pulse applied to the IN_SYNC input is 100 μs. The maximum frequency applied to the IN_SYNC input is 1 pulse every 5 ms. The maximum user-defined preset value is 4,294,967,295. The maximum count value is 4,294,967,295 units.</p>
Loop (modulo) counting	<p>This mode is used in packaging and labeling applications where actions are repeated on sets of moving objects:</p> <ul style="list-style-type: none"> <li>■ In upcounting, the counter increases until it reaches the user-defined "modulo - 1" value. On the next pulse, the counter is reset to 0 and upcounting restarts.</li> <li>■ In downcounting, the counter decreases until it reaches 0. On the next pulse, the counter is reset to the user-defined "modulo - 1" value. Downcounting can then restart.</li> </ul> <p>The maximum frequency applied to the IN_A and IN_B inputs is 60 kHz. The maximum frequency of the modulo event is 1 event every 5 ms. The maximum modulo value is 4,294,967,296 (possible by declaring 0 in the modulo adjust value).</p>
32-bit counter counting	<p>This mode is mainly used in axis following.</p> <p>The maximum frequency applied simultaneously to the IN_A and IN_B inputs is 60 kHz. The maximum frequency of the referencing event is 1 event every 5 ms. The counter value is between -2,147,483,648 and +2,147,483,647.</p>
Width modulation	<p>In this operating mode, the module uses an internal clock generator to supply a periodic signal on the module's O0 output. Only the O0 output is affected by this mode, as the O1 output is independent of it.</p> <p>The maximum output frequency is 4 kHz. As O0 is a source output, a load resistor is necessary for the O0 output signal to change to 0 at the correct frequency. The cyclic ratio adjustment range varies according to the frequency of the O0 output.</p>

#### Operating modes for module BMXEHC0800

<b>5 configurable 16-bit modes</b>	Frequency meter	<p>This mode measures a frequency, speed, rate, or data stream control. As standard, this mode measures the frequency received on the IN A input. This frequency is expressed in Hz (number of pulses per second), with a precision of 1 Hz.</p> <p>The maximum frequency on the IN A input is 10 kHz. The maximum cyclic ratio at 10 kHz is 60%.</p>
	Event counting	<p>This mode is used to determine the number of events received. In this mode, the counter calculates the number of pulses applied to the IN_A input at time intervals defined by the user. As an option, it is possible to use the IN_AUX input during a period of time, provided that the enable bit has been configured.</p> <p>The module counts the pulses applied to the IN_A input each time the pulse for this input lasts longer than 50 μs (without anti-bounce filter). Pulses with less than 100 ms synchronization are lost.</p>
	Downcounting	<p>This mode is used to list a group of operations. In this mode, when counting is enabled (software validation via the valid_sync command), a rising or falling edge on the IN_AUX input causes a value, defined by the user, to be loaded in the counter. The latter decreases with each pulse applied to the IN_A input until it reaches the value 0. Downcounting is made possible when the force_enable command is high (software positioning).</p> <p>The smallest pulse applied to the IN_AUX input varies according to the selected filter level. The maximum frequency applied to the IN_AUX input is 1 pulse every 25 ms.</p>
	Loop (modulo) counting	<p>This mode is used in packaging and labeling applications where actions are repeated on sets of moving objects. The counter increases with each pulse applied to the IN_A input until it reaches the user-defined "modulo - 1" value. On the next pulse in the upcounting direction, the counter is reset to 0 and upcounting restarts.</p> <p>The maximum frequency applied to the IN_A input is 10 kHz. The smallest pulse applied to the IN_AUX input varies according to the selected filter level. The maximum frequency of the modulo event is 1 event every 25 ms. The maximum modulo value is 65,536 units.</p>
	Up/down counter	<p>This mode is used for an accumulation, upcounting, or downcounting operation on a single input. Each pulse applied to the IN_A input produces:</p> <ul style="list-style-type: none"> <li>■ Upcounting of pulses if the IN_AUX input is high</li> <li>■ Downcounting of pulses if the IN_AUX input is low</li> </ul> <p>The counter values vary between the limits -65,536 and +65,535. The maximum frequency applied to the IN_A input is 10 kHz. Pulses applied to the IN_A input after a change of direction are only upcounted or downcounted after a period corresponding to the delay for taking account of the state of the IN_AUX input due to the programmable filter level on this input.</p>
<b>One 32-bit mode</b>	32-bit counter counting	<p>32-bit counter counting mode is available for channels 0, 2, 4, and 6 (channels 1, 3, 5, and 7 are now inactive). It behaves in the same way as the up/down counting mode using up to 3 physical inputs. It enables simultaneous upcounting and downcounting.</p> <p>The counter values vary between the limits -2,147,483,648 and +2,147,483,647 (31 bits + sign). The maximum frequency applied to the IN_A and IN_B inputs is 10 kHz. The smallest pulse applied to the IN_AUX input is defined according to the filtering applied to this input. The maximum frequency of loading the preset value is 1 every 25 ms.</p>



BMXEHC0200



BMXEHC0800

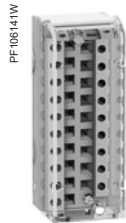

BMXFTB2000

#### References

##### X80 counter modules (1)

Description	No. of channels	Characteristics	Reference	Weight kg/lb
<b>Counter modules</b> for 24 V ---	2	60 kHz counting	<a href="#">BMXEHC0200</a>	0.112/ 0.247
2 and 3-wire sensors and 10/30 V --- incremental encoders with push-pull outputs	8	10 kHz counting	<a href="#">BMXEHC0800</a>	0.113/ 0.249

##### Connection accessories (2)

Description	Composition	Unit reference	Weight kg/lb
<b>Pack of connectors</b> for BMXEHC0200 module	Two 16-way connectors and one 10-way connector	<a href="#">BMXXTSHSC20</a>	0.021/ 0.046
<b>20-way removable terminal blocks</b> for BMXEHC0800 module	Caged	<a href="#">BMXFTB2000</a>	0.093/ 0.205
	Screw clamp	<a href="#">BMXFTB2010</a>	0.075/ 0.165
	Spring	<a href="#">BMXFTB2020</a>	0.060/ 0.132

**Shielding connection kit** Comprising a metal bar and two support bases for mounting on rack for X80 counter modules See [page 2/5](#) -

(1) Typical consumption: See the power consumption table available on our website [www.se.com](http://www.se.com).

(2) The shielding on the cordsets carrying the counter signals must always be connected to the **BMXXSP0000** shielding connection kit mounted under the rack that holds the **BMXEHC0200** module (see [page 2/3](#)).



BMXERT1604T/BMXERT1604H

#### Presentation

The **BMXERT1604T/H** time-stamping module is a complete solution providing a SCADA with a sequence of events that are time-stamped at source, enabling the user to analyze the source of any abnormal behavior in an automated system.

The SOE (sequence of events) is displayed in the alarms log or in the list of events for a client such as a SCADA.

Each event in the SOE is a change of value (transition) of a discrete I/O detected by a time-stamping module.

#### Advantages

Using the time-stamping system has the following advantages:

- No PLC programming
- Direct communication between the time-stamping modules and the client; if the time-stamping modules are in a Quantum Ethernet I/O drop, the bandwidth of the PLC communication is not used
- Consistency of the I/O values between the process (time-stamping modules) and the client
- Consistency is maintained irrespective of the operating mode
- No loss of events under normal operating conditions
- Management of Hot Standby configurations on the PLC and/or SCADA redundancy

#### Composition of a time-stamping architecture

##### X80 Remote I/O drop adapter

The **BMXERT1604T/H** module can be at the source of any discrete I/O signal located in the drop with a resolution of 10 ms. To help ensure no event is lost, all events are stored and kept in a buffer located in the product until OFS takes them.

The NTP protocol is used to synchronize the X80 Remote I/O drop adapter (BM●CRA312●0).

##### X80 Time-stamping module

The **BMXERT1604T/H** time-stamping module has 16 discrete inputs which carry out the time-stamping at source outputs with a resolution of 1 ms.

To help ensure no event is lost, all events are stored and kept in a buffer located in the product until OFS takes them.

This module can be placed either in an RIO drop, or in a local rack equipped with a X80 Remote I/O drop adapter which is synchronized via the DCF 77 or IRIG-B standards.

##### OFS V3.60 software

OFS V3.60 software is used to access events stored in the various buffers in the architecture and to place them in the SCADA via the standard OPC DA protocol. For further information, consult our website [www.se.com](http://www.se.com).

##### AVEVA Plant SCADA

AVEVA Plant SCADA receives events transmitted by OFS and displays them in the SOE or in the list of alarms. For further information, consult our TPP partner website [www.se.com/en/partners/technology-partners/](http://www.se.com/en/partners/technology-partners/).



#### Performance

Performance	Event source module	Value
Between two identical source modules in the same rack	BMXERT1604T	1.6 < resolution < 3.3 ms
	BMXERT1604H	
	BM●CRA31210	10 ms
Between two different inputs in the same source module	BMXERT1604T	1 ms
	BMXERT1604H	
	BM●CRA31210	1 scan
Maximum buffer	BMXERT1604T BMXERT1604H	255 groups (1)
Maximum number of discrete inputs/outputs monitored by the PLC for the entire time-stamping module	BMXERT1604T	400 discrete inputs (2)
	BMXERT1604H	
	BM●CRA31210	2,048 discrete I/Os (2)
Maximum number of I/O and memory available	BMXERT1604T	16 discrete inputs on module
	BMXERT1604H	255 groups (3)
	BM●CRA31210	256 discrete I/O configured 4,000 events in internal buffer
Maximum number of source modules in an Ethernet remote drop	BM●CRA31210	1 per drop
	BMXERT1604T	9 per drop
	BMXERT1604H	
Maximum number of sources of events polled by OFS	BMXERT1604T BMXERT1604H	500 sources per second (2)

#### References

##### X80 Time-stamping modules

Description	Input type	Reference	Weight kg/lb
Multifunction time-stamping input module	16 discrete inputs	<a href="#">BMXERT1604T</a>	0.119/ 0.262
Multifunction time-stamping input module for severe environments		<a href="#">BMXERT1604H</a>	

##### Connection accessories for time-stamping modules

Description	For use with modules	Type, composition	Length	Reference	Weight kg/lb
28-way removable terminal blocks	BMXERT1604T BMXERT1604H	Caged	–	<a href="#">BMXFTB2800</a>	0.111/ 0.245
		Spring	–	<a href="#">BMXFTB2820</a>	0.080/ 0.176

(1) A group is a set of 1 to 16 events detected in the same cycle.

(2) This maximum value is not an absolute value. It depends on the overall system dynamics (total number of scanned items and number of events generated by the system).

(3) The event number contained in one group varies within 1..16. It depends on how many channels get the events occurred within same sampling window (0.5ms).

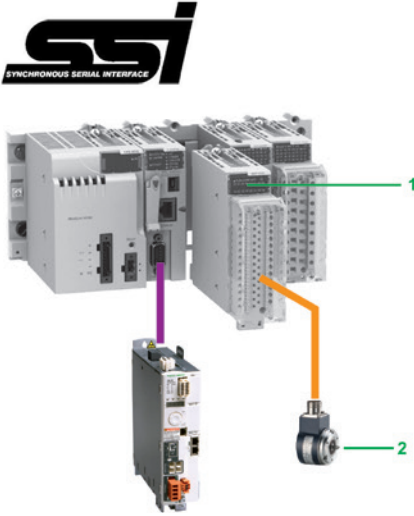

Modicon X80 module platform with Modicon M340 processor

#### Presentation

The **BMXEAE0300** SSI encoder interface module **1** for the Modicon automation platform (1) is a 3-channel standard synchronous serial interface module designed for use with SSI absolute encoders **2**.

The **BMXEAE0300** module enables SSI encoder values to be processed on PAC platforms for applications requiring accurate position/angular control, such as:

- Hydro power, e.g. dam inlet gate position control
- Wind power, e.g. wind turbine blade pitch control
- Complex motion loop control, e.g. ship elevator, blast furnace, flame cutting, etc.

The **BMXEAE0300** module provides a migration path from Premium (with **TSXCTY2C** measurement and counter module) to the Modicon X80 module platform SSI solution to compete in the above market segments.

Like any other application-specific module, the **BMXEAE0300** module is installed in the rack slots (01 to 11). The number of modules is limited by the maximum number of application-specific channels permitted according to the CPU type (consult our website [www.se.com](http://www.se.com)).

#### Dam inlet gate control

Inlet gate control enables the water level in a dam to be monitored and controlled:

- The SSI encoder provides the PLC with accurate feedback of the gate position for precise monitoring of gate opening, adjustment, and positioning.
- The SSI interface converts the signals from the SSI encoders and transmits them to the CPU.

#### Wind turbine blade pitch control

Pitch control is required for adjusting the angle of the wind turbine blades in relation to the wind direction and strength, in order to achieve optimum energy conversion efficiency.

- The SSI absolute encoder is frequently used to feed back the position of the blade due to its reliability and robustness.
- Typically, the position of each of the three blades is read by the SSI encoders and then transmitted to the CPU via the SSI interface for motion loop control. Sometimes, 3 additional SSI inputs act as backup. Therefore, this new offer is adequately sized for the channel density.

#### Description

The **BMXEAE0300** SSI encoder interface module is standard format (1 slot). Its housing provides IP20 protection of the electronics and it is locked in each slot (**01** to **11**) by a captive screw.

The front panel of the **BMXEAE0300** module features:

- 1** A rigid housing providing support and protection for the electronic card
- 2** The module reference marking (a label is also visible on the right-hand side of the module)
- 3** A display block indicating:
  - Module status via 4 LEDs:
    - RUN (green): module operating status
    - ERR (red): internal fault detected in the module or a fault detected between the module and the rest of the configuration
    - I/O (red): external fault detected
    - DL (green): firmware download status
  - Status of the 3 SSI channels via 8 LEDs:
    - Sx (green): channel x input (x = 0, 1, or 2)
    - Qx (green): reflex output for channel x (x = 0, 1, or 2)
    - IO/1 (green): capture inputs for the 3 SSI channels
- 4** A connector for a 28-way terminal block, for connecting to a removable caged or spring terminal block on sensors and preactuators

**To be ordered separately:**

- 5** A **BMXFTB2800** 28-way removable caged terminal block or **BMXFTB2820** spring terminal block, supplied with a channel identification label (see [page 6/11](#))
  - A shielding connection kit to help protect against electrostatic discharge, consisting of a metal bar and two sub-bases for mounting on the rack: **BMXXSP●●00** (reference dependent on the number of slots in the rack) (see [page 2/5](#))
  - A set of clamping rings **STBXSP30●0** for the connection cable shielding braids (reference dependent on the cable diameter) (see [page 2/5](#))

(1) Only for the Modicon automation platforms compatible with Modicon X80 module platform

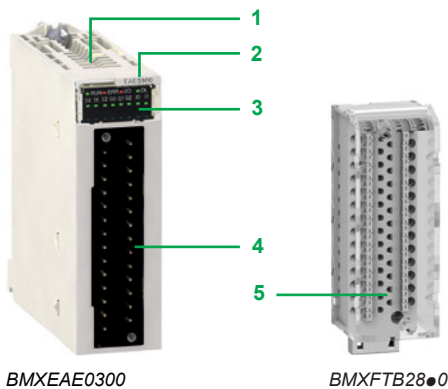

BMXEAE0300

BMXFTB2800



#### Module specifications and functions

##### Specifications

The **BMXEAE0300** SSI encoder interface module is a 3-channel, synchronous serial interface, absolute encoder interface for Modicon PLCs. It supports:

- 3 channels of SSI inputs (DATA pair, CLK pair, 24 VDC field power supply to encoder)
- 1 reflex output for each SSI channel (Q)
- 2 capture inputs for the 3 SSI channels (CAP\_IN0, CAP\_IN1)
- 8 to 31 bits data width
- 4 baud rates (100 kHz, 200 kHz, 500 kHz, and 1 MHz)
- Capture and compare functions

##### Basic and optional functions

The following table presents the main functions of the **BMXEAE0300** module:

Function	Basic/ optional	Description
Absolute SSI encoder value acquisition	Basic	The position values of the SSI channel are automatically read by the module within 1 ms, unless the channel is disabled.
Modulo	Optional for motion	The modulo function limits the dynamics of the position value to within the power of 2. An event (if enabled) detects the passing of the modulo. The reflex output can also be detected when the modulo is passed (if configured).
Reduction	Optional for motion	This function reduces the intrinsic resolution of the encoder by a value defined by the "reduction" parameter. This reduction is carried out by a shift in the bit field provided by the encoder.
Offset	Optional for motion	The correction function of the encoder offset systematically corrects the offset produced by the encoder at mechanical position "0". The user enters the absolute encoder offset parameter.
Capture	Optional for events	The two capture input registers (per channel) enable the PLC program to carry out a dynamic measurement function between two points. The capture action can be triggered by two capture inputs. The event will be triggered at each capture.
Compare	Optional for events	Two independent comparators (per channel), with thresholds that can be modified by adjustment (explicit exchange), are able to generate an event or reflex output when the threshold is crossed.



EcoStruxure Control Expert monitor



BMXEAE0300



BMXFTB2800

##### Main features

- Supported by EcoStruxure Control Expert (1).
- Supports absolute encoder 24 V model with standard SSI interface, including Telemecanique Sensors OsiSense SSI encoders. For further information, consult the website [www.tesensors.com](http://www.tesensors.com).
- Standards and approvals: CE, UL, CSA, C-Tick, GOST, etc.

##### References

###### X80 SSI encoder interface module (2)

Description	Number of channels	Description per channel	Reference	Weight kg/lb
SSI encoder interface module	3 SSI channels	1 reflex output for each SSI channel 2 capture inputs for the 3 SSI channels 8 to 31 bits data width 4 baud rates: 100 kHz, 200 kHz, 500 kHz, 1 MHz Capture and compare functions	<a href="#">BMXEAE0300</a>	0.138/ 0.304

###### Cabling accessories

Description	Description, use	Reference	Weight kg/lb
28-way removable terminal block	Caged	<a href="#">BMXFTB2800</a>	0.111/ 0.245
	Spring	<a href="#">BMXFTB2820</a>	0.080/ 0.176
Shielding connection kit for BMXEAE0300 module (3)	Comprising a metal bar and two support bases for mounting on rack	See <a href="#">page 2/5</a>	–

(1) EcoStruxure Control Expert software continues the range of Unity Pro software and corresponds to versions  $\geq 14$  of Unity Pro.

(2) Typical consumption: See the power consumption table available on our website [www.se.com](http://www.se.com).

(3) The shielding on the cables carrying the power supply to the module, each SSI channel, the capture inputs, and the reflex outputs (if any of them is wired) must always be connected to the **BMXXSP0000** shielding connection kit mounted under the rack holding the **BMXEAE0300** module (see [page 2/3](#)).

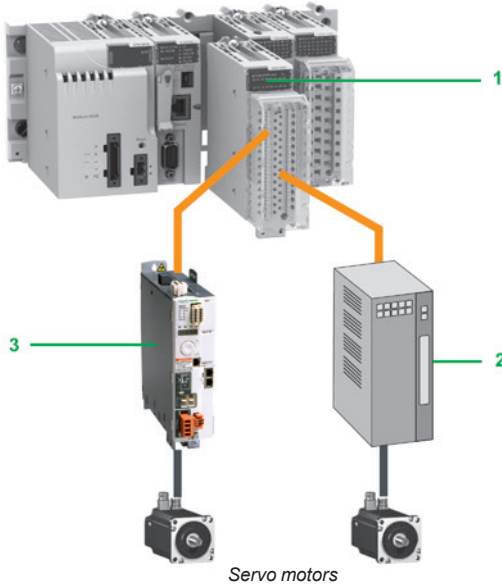

Servo motors

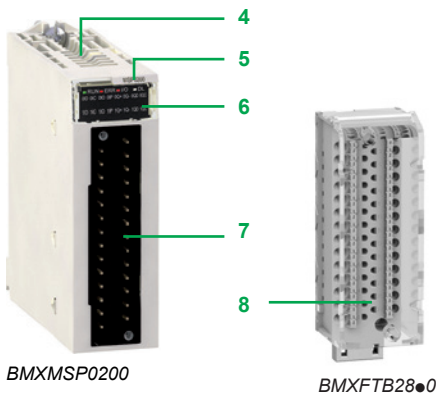

BMXMSP0200

BMXFTB2800



DIA6ED2151012EN

### Presentation

The **1 BMXMSP0200** motion control pulse train output (PTO) module for the Modicon X80 module platform is used for controlling third-party variable speed drives **2**, which have an integrated position loop and inputs that are compatible with open collector outputs.

The **BMXMSP0200** Motion control module is also directly compatible with the Lexium 32C and 32M **3** servo drive ranges, which have an integrated pulse control interface.

The **BMXMSP0200** motion control PTO module has two independent PTO channels. Like any other application-specific module, it is installed in the rack slots (labeled **01** to **11**). The number of modules is limited by the maximum number of application-specific channels permitted according to the CPU type:

- Standard **BMXP341000**: Maximum of 20 application-specific channels (1)
- Performance **BMXP342000**: Maximum of 36 application-specific channels (1)
- **BMEP5810**: Maximum of 24 application-specific channels (1)
- **BMEP5820**: Maximum of 32 application-specific channels (1)
- **BMEP5830** and **BMEP5840**: Maximum of 64 application-specific channels (1)
- **BMEP585040**: Maximum of 180 application-specific channels (1)
- **BMEP586040**: Maximum of 216 application-specific channels (1)

### Description

The **BMXMSP0200** motion control module is standard format (1 slot). Its housing provides IP20 protection of the electronics and it is locked in each slot (**01** to **11**) by a captive screw.

The front panel of the **BMXMSP0200** motion control module features:

- 4** A rigid body providing support and protection for the electronic card
- 5** A module reference marking (a label is also visible on the right-hand side of the module)
- 6** A display block indicating:
  - Module status via 4 LEDs (RUN, ERR, I/O, and DL)
  - Status of the auxiliary inputs, 4 per channel
  - Status of the PTO outputs, 2 per channel
  - Status of the auxiliary outputs, 2 per channel
- 7** A connector for a 28-way terminal block, for connecting to a removable spring terminal block on sensors and preactuators

To be ordered separately:

- 8** A **BMXFTB2800** 28-way removable caged terminal block or **BMXFTB2820** spring terminal block, supplied with a channel identification label (see [page 6/11](#))
  - A shielding connection kit to help protect against electrostatic discharge, consisting of a metal bar and two sub-bases for mounting on the rack: **BMXXSP0000** (reference dependent on the number of slots in the rack) (see [page 2/5](#))
  - A set of clamping rings **STBXSP3000** for the connection cable shielding braids (reference dependent on the cable diameter) (see [page 2/5](#))

(1) Application-specific channels: **BMXEHC0200** (2-channel) and **BMXEHC0800** (8-channel) counter modules, **BMXMSP0200** (2-channel) motion control module, **BMXNOM0200** (2-channel) and **BMXNOR0200H** (1-channel) serial communication modules, **BMEAH10812** (8-channel) analog input module and **BMEAH00412** (4-channel) analog output module, **BMXAE0300** (3-channel) SSI module and **BMXERT1604T/H** (16-channel) discrete input module.

### Operation

#### Block diagram of a BMXMSP0200 module channel

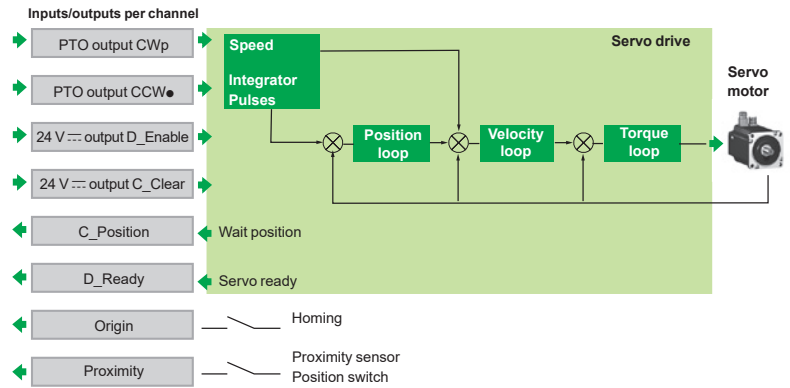

BMXMSP0200

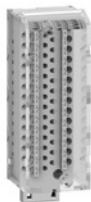

BMXFTB2800

### References

#### X80 Motion control module (1)

Description	Number of channels	Description per channel	Reference	Weight kg/lb
PTO module	2	2 x 200 kHz max. PTO outputs 2 x 24 V ---/50 mA auxiliary outputs 4 x 24 V --- auxiliary inputs	<a href="#">BMXMSP0200</a>	0.145/ 0.320

#### Cabling accessories

Description	Description, use	Length	Reference	Weight kg/lb
28-way removable terminal block	Caged Spring	–	<a href="#">BMXFTB2800</a> <a href="#">BMXFTB2820</a>	0.111/ 0.245 0.080/ 0.176

<b>Connection cable</b> for daisy chain or pulse control (2)	From BMXMSP0200 (screw clamp terminal block) module to Lexium 32C or 32M (RJ45 connector) (cable with flying leads at one end and an RJ45 connector at the other)	3 m/9.84 ft	<a href="#">VW3M8223R30</a>	–
---	---	-------------	-----------------------------	---

<b>Shielding connection kit</b> for module BMXMSP0200	Comprising a metal bar and two support bases for mounting on rack	–	See <a href="#">page 2/5</a>	–
--	---	---	------------------------------	---

(1) Typical consumption: See the power consumption table available on our website [www.se.com](#).

(2) The shielding on the cordsets carrying the motion control signals must always be connected to the **BMXXSP●●00** shielding connection kit mounted under the rack holding the **BMXMSP0200** module (see [page 2/3](#)).

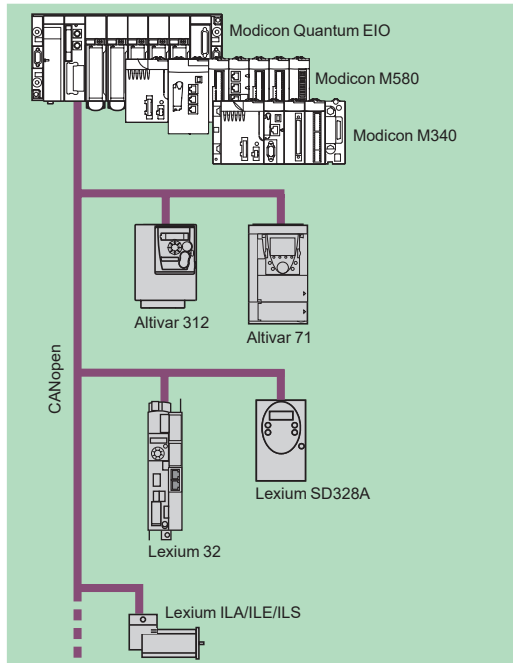

MFB: Motion control distributed over CANopen



### Presentation

MFB (Motion Function Blocks) is a library of function blocks integrated in EcoStruxure Control Expert (1) used to set up motion control in the architectures of drives and servo drives on CANopen buses:

- Altivar 312: For asynchronous motors from 0.18 to 15 kW/0.25 to 20 HP
- Altivar 71: For synchronous or asynchronous motors from 0.37 to 500 kW/0.5 to 700 HP
- Lexium 32: For servo motors from 0.15 to 7 kW/0.20 to 10 HP
- Lexium ILA/ILE/ILS: Integrated motor drives from 0.10 to 0.35 kW/0.13 to 0.47 HP
- Lexium SD328A: For 3-phase stepper motors from 0.35 to 0.75 kW/0.47 to 1 HP

In compliance with PLCopen specifications, the MFB library allows both easy and flexible motion programming with EcoStruxure Control Expert (1), as well as axis diagnosis.

In maintenance operations, drives can be replaced quickly thanks to drive parameter download blocks.

Setting up drives on the CANopen network is facilitated through Motion Tree Manager organization in the EcoStruxure Control Expert (1) browser, making it easy for users to access the application drives.

### Applications

The features of the Motion Function Blocks library are particularly suitable for machines with independent axes. In the case of these modular/special machines, MFB function blocks are an ideal solution for controlling single axes. The following are typical applications for this type of architecture:

- Automatic storage/removal
- Material handling
- Palletizers/depalletizers
- Conveyors
- Packaging, simple labeling application
- Grouping/ungrouping
- Adjustment axes in flexible machines, etc.

### Functions

The table below lists the function blocks of the MFB library and the compatible drives. The prefix indicates the block family:

- MC: Function block defined by the Motion Function Blocks PLC Open standard
- TE: Function block specific to Schneider Electric products
- Lxm: Function block specific to Lexium servo drives

Type	Function	Function block	Altivar 312	Altivar 71	Lexium 32	Lexium ILA/ILE/ILS	Lexium SD328A
<b>Management and motion</b>	Read an internal parameter	MC_ReadParameter					
	Write an internal parameter	MC_WriteParameter					
	Read the current position	MC_ReadActualPosition					
	Read the instantaneous speed	MC_ReadActualVelocity					
	Acknowledge detected error messages	MC_Reset					
	Stop any active movement	MC_Stop					
	Axis coming to standstill	MC_Power					
	Movement to absolute position	MC_MoveAbsolute					
	Relative movement	MC_MoveRelative					
	Additional movement	MC_MoveAdditive					
	Homing	MC_Home					
	Movement at given speed	MC_MoveVelocity					
	Read diagnostic data	MC_ReadAxisError					
	Read servo drive status	MC_ReadStatus					
	Torque control	MC_TorqueControl					
	Read actual torque value	MC_ReadActualTorque					
Manual control	MC_Jog						
<b>Save and restore parameters (FDR)</b>	Read drive parameters and store in PLC memory	TE_UploadDriveParam					
	Write drive parameters from PLC memory	TE_DownloadDriveParam					
<b>Advanced Lexium functions</b>	Read a motion task	Lxm_UploadMTask					
	Write a motion task	Lxm_DownloadMTask					
	Start a motion task	Lxm_StartMTask			(1)		
	Set the reduction ratio, signed	Lxm_GearPosS			(1)		
<b>System</b>	Communication with the servo drive	TE_CAN_Handler					

Compatible

(1) The Lxm\_StartMTask and Lxm\_GearPosS function blocks are only compatible with Lexium 32 (LXM32M) servo drives.

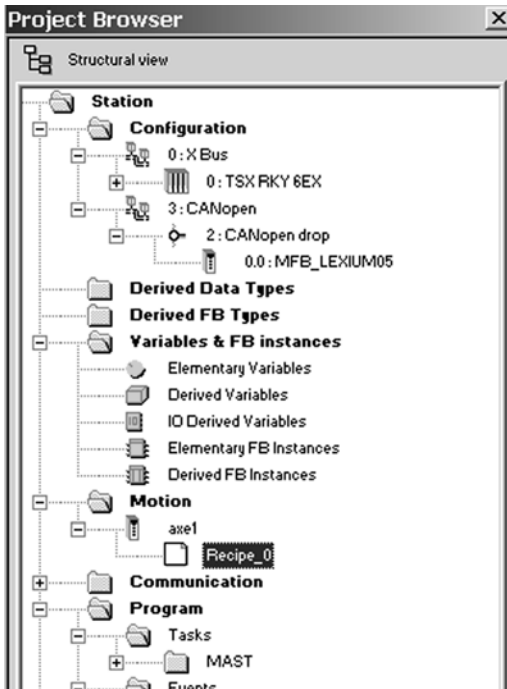

Motion Tree Manager integrated in the EcoStruxure Control Expert browser

### Motion Tree Manager

Motion Tree Manager is associated with MFB library of EcoStruxure Control Expert (1) and integrated in its browser. It provides specific assistance for:

- Axis object management
- Axis variable definition
- Drive parameter management

Motion Tree Manager automatically creates links between the CANopen bus configuration and the MFB function block data using a limited amount of configuration data.

### General axis parameters

In this tab, the designer is prompted to define:

- The name of the axis that will identify it in the browser for the entire application
- The address of the drive on the CANopen bus

### Axis parameters

The drop-down lists in this tab are used to determine the exact type of drive: family, version.

### Variable names

This last tab is used to identify data structures:

- **Axis\_Reference**: Used by the function block instances for the axis in question
- **CAN\_Handler**: Used to manage communication with the drive via the CANopen network

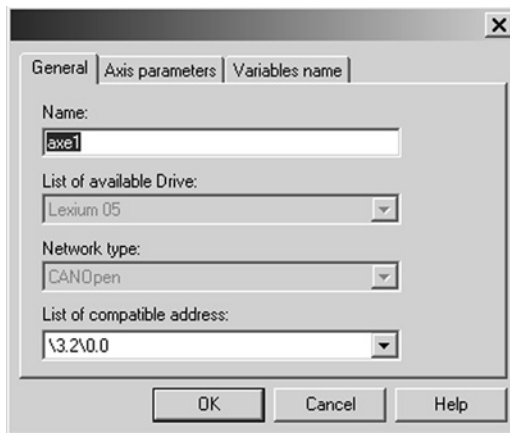

General parameters: Axis name and address

### Recipe definition

The recipes attached to the axis are the data structures containing the adjustment parameters of a given drive. This data is used when:

- Changing the drive with restoration of the context during "Faulty Device Replacement" (FDR) maintenance
- Changing the manufacturing program of the machine and calling up an appropriate set of parameters: servo control gains, limitations, etc. adapted to the weight and size of the moving parts
- Saving parameters in the initial values of the PLC application

### Programming, diagnostics, and maintenance

Communication between the PLC and drive is automatically set up by the system as soon as a TE\_CAN\_Handler instance is declared in the EcoStruxure Control Expert (1) task with which the axis is associated. Movements are then programmed by sequencing function blocks from the library in the user's chosen EcoStruxure Control Expert (1) editor (LD, ST, FBD).

The two function blocks, MC\_ReadStatus, and in some cases MC\_ReadAxisError, are useful for determining the overall status of the axis, as well as the code of the active detected errors.

The function blocks TE\_UploadDriveParam and TE\_DownloadDriveParam allow the application to save the drive parameters (recipe) and to then quickly reload them into another drive when it is necessary to change the original one.

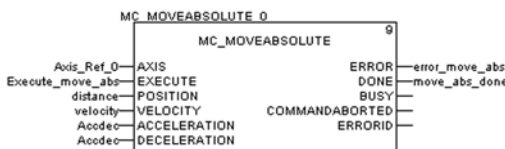

MFB: Programming a movement in absolute mode

(1) EcoStruxure Control Expert software continues the Unity Pro range of software and corresponds to versions ≥ 14 of Unity Pro.

#### Presentation

The **BMXETM0200H** frequency input module offers turbine shaft and engine speed monitoring functionality for general purpose turbomachinery control (TMC) applications. It can be integrated into Modicon M340 and M580 standard and high-availability systems.

TMC applications include prime movers, driven equipment, auxiliaries, mechanical retrofits, and protection. With the Modicon Package solution, the frequency input and measurement function is available for the following general purpose TMC application types:

- Large hydro turbines
- Small steam turbine generators
- Small hydro turbines
- Small mechanical drive gas turbines
- Diesel generators
- Reciprocating compressors
- Packaged air compressors
- Single-stage mechanical drive turbines: pumps

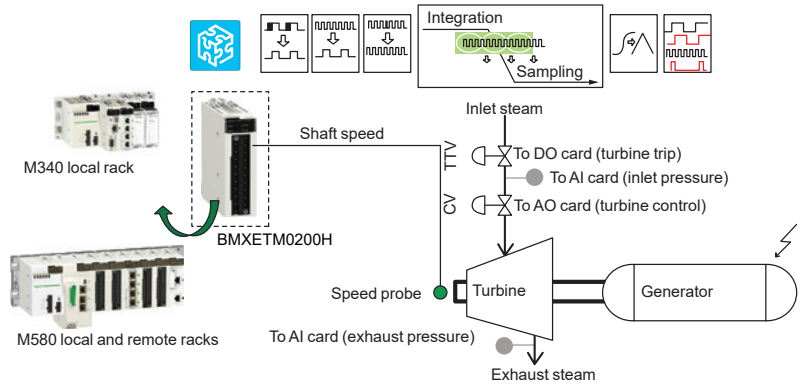

TMC governor control system architecture

#### Functionality

The purpose of the **BMXETM0200H** module is to monitor the turbine shaft or engine speed. It is designed to receive electrical pulses generated by the gear tooth sensing probe, cam, and crank etc. and convert these pulses into a numerical value. The measured value of the turbine shaft rotating velocity is highly accurate with a fast refresh rate.

With the **BMXETM0200H** module providing frequency input and measurement, Modicon PACs build up a closed loop control system as part of the turbomachinery governor. This control mechanism will automatically track and direct the speed of driven equipment (such as a generator or compressor) and a prime mover (such as a turbine or engine) under varying load conditions with the aim of:

- maintaining the selected speed
- limiting slow and fast speeds
- helping to protect mechanical parts and customer investment by anticipating overspeeds by means of its acceleration and jerk detection capability



BMXETM0200H

# Modicon X80 module platform

## X80 Expert modules

### Frequency input module

#### Module specifications

##### Availability and compatibility

Available for Modicon M340 and M580 standalone and HSBY platforms, on local rack or RIO rack with hot swapping supported.

##### Ambient operating temperature

Hardened with extended temperature range from  $-25...70\text{ }^{\circ}\text{C}/-13...158\text{ }^{\circ}\text{F}$  and conformal coating.

##### Measurement performance

Two frequency input channels for 1 V and 1 Hz signal up to a maximum of 500 KHz with 100 KHz, 10 KHz, and 1 KHz input filters.

##### Supported signal source device type

Speed sensor inputs support passive pickup, active speed sensor (output OC, TTL, ST), potential transformer, and incremental encoder.

##### Digital reflex outputs

1 positive 24 VDC reflex digital output per channel controlled from an embedded comparator.

##### Error detection

Detects broken wire and probe health status.

##### Dedicated TMC functions

A set of dedicated TMC functions for turbine shaft monitoring, including:

- Frequency pattern recognition up to 512 pulses per pattern
- Acceleration and jerk detection
- Phase angle and ratio detection between channels
- Scaling factor for RPM measurement up to 1,024 teeth per revolution
- Alarm bits that can be time-stamped by the Modicon M580 controller

##### Software configuration

Configurable using EcoStruxure Control Expert (1) or Unity Pro V11 (S, L, and XL) with TMC Hotfix integrated.

#### Reference

##### X80 Frequency input module

Description	Composition	Reference	Weight kg/lb
Turbomachinery frequency input module (2 channels) for severe environments	1 ms cycle time	<a href="#">BMXETM0200H</a>	0.124/
	2 digital reflex outputs 2 discrete inputs (for frequency measurement functions)		0.273

(1) EcoStruxure Control Expert software continues the Unity Pro range of software and corresponds to versions  $\geq 14$  of Unity Pro.

Technology  
Partner

Schneider  
Electric

PMESWT0100 Scaime partner  
weighing module

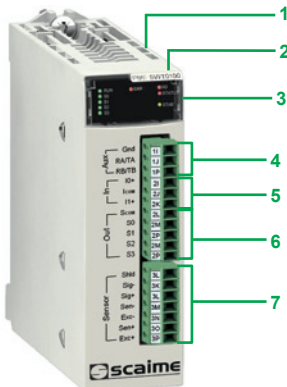

PMESWT0100

6

### Presentation

The **PMESWT0100** Scaime partner weighing module is integrated in a Modicon X80 module platform with an Ethernet + X-bus **BMEXBP●●00(H)** rack and a Modicon M580 **BMEP58●●0●0** PLC or in a Modicon X80 RIO drop with an Ethernet + X-bus **BMEXBP●●00(H)** rack and a **BMECRA31210** adapter.

With this module, it is possible to go beyond the scope of a simple weighing application: it is suitable for static weighing applications such as silo level measurement and scale weighing; it is also well suited to low-speed dynamic weighing applications such as filling, dosing, and material transfer.

The Modicon X80 module platform can manage the whole weighing environment as well as the whole machine or industrial process associated with the weighing system.

Indeed, weighing data is accessible by the PLC via implicit exchanges or explicit commands. Once the weighing signal is received, it is processed and transferred by the weighing module to the Modicon M580 PLC via the Ethernet backbone. This Ethernet weighing transmitter offline configuration, online calibration, monitoring, and weighing diagnostics are achieved using EcoStruxure Control Expert (1) software via FDT/DTM.

The Scaime partner weighing module has been developed to comply with the general standards and certifications of the Modicon X80 module platform. For more information, see [page 10/2](#) or consult our website [www.se.com](#).

### Description

The **PMESWT0100** weighing module features the following:

- 1 A rigid body providing support and protection for the electronic card
- 2 A module reference marking (a label is also visible on the right-hand side of the module)
- 3 A module and channel status display block
- 4 Screw clamp terminals for connecting an external HMI output
- 5 Screw clamp terminals for connecting discrete reflex inputs
- 6 Screw clamp terminals for connecting discrete reflex outputs
- 7 Screw clamp terminals for connecting input load cells

### Main characteristics

#### Measurement input

1 weighing channel per module, comprising up to 8 load cells connected via junction box

#### Input load cell supply voltage

5 V  $\overline{\text{DC}}$

#### Internal resolution

24-bit converter

#### User resolution

Up to 1,000,000, factory-calibrated 500,000 at 2 mV/V

#### Internal measurement rate

6 to 400 measurements per second

#### External measurement rate

100 measurements per second

#### Discrete reflex outputs

#### Number of applications

4 positive logic outputs, 2 for dosing and 2 for threshold monitoring

#### Maximum voltage

55 V  $\overline{\text{DC}}$

#### Nominal current

400 mA

#### Response time

2 ms discrimination

#### Discrete inputs

#### Number of applications

2 positive logic inputs, weighing functions

#### Low voltage range

0...3 V  $\overline{\text{DC}}$

#### High voltage range

9...28 V  $\overline{\text{DC}}$

#### High current

20 mA at 24 V  $\overline{\text{DC}}$

(1) EcoStruxure Control Expert software continues the Unity Pro range of software and corresponds to versions  $\geq 14$  of Unity Pro.



# Modicon X80 module platform

## X80 Expert modules

### Weighing module



PMESWT0100

#### References

##### X80 Weighing module

Description	Composition	Reference	Weight kg/lb
<b>Scaime partner weighing module (1)</b> (1 weighing channel per module)	<ul style="list-style-type: none"> <li>- Load cell input 100 measurements/s (for 1 to 8 load cells)</li> <li>- 4 discrete reflex outputs (for threshold monitoring and dosing)</li> <li>- 2 discrete inputs (for weighing functions)</li> <li>- 1 output for an external HMI</li> </ul>	<b>PMESWT0100</b> (2)	0.233/ 0.514

Technology  
Partner

Schneider  
Electric

(1) Partner Product, sold by SE and Scaime. Supported by Scaime, see our website [www.se.com/en/partners/technology-partners/](http://www.se.com/en/partners/technology-partners/)

(2) To order this product, please contact our Customer Care Center.



---



*Selection guide* ..... page 7/2

## **X80 Remote I/O drop adapters**

- X80 Offer presentation ..... page 7/4
- Characteristics, references ..... page 7/4
- Performance and Standard adapters, Description ..... page 7/5

## **X80 Peripheral remote I/O drop adapter**

- Presentation ..... page 7/6
- Description, references ..... page 7/6

Applications	X80 RIO drop adapter	X80 RIO drop adapter	X80 RIO drop adapter
Type of device	Standard	Performance	Performance
			
<b>Network protocols</b>	EtherNet/IP		
<b>Racks</b>	Up to 2		
<b>Structure</b>	10BASE-T/100BASE-TX		
	2xRJ45: ■ 2 connectors for RIO network (RSTP ring topology)	3xRJ45: ■ 1 connector for service ■ 2 connectors for RIO network (RSTP ring topology)	3xRJ45: ■ 1 connector for service ■ 2 connectors for RIO network (RSTP ring topology)
	No		Yes
	CSMA-CD		
	10/100 Mbps		
<b>Medium</b>	Double shielded twisted pair copper cable, category CAT 5E		
<b>Dimension</b>	32 x 100 x 86 mm / 1.25 x 3.93 x 3.38 in.		
<b>Remote X80 I/O</b>	Up to 128	Up to 1024	
	Up to 16	Up to 256	
<b>I/O modules supported</b>	All BMXA●●●●●●		
	All BMXD●●●●●●		
			BMEAHI0812/BMEAHO0412
<b>Communication modules supported</b>		BMXNOM0200	BMXNOM0200
		BMXEIA0100	BMXEIA0100
			PMEPXM0100 (1)
			BMECXM0100 (1)
			BMENOS0300
<b>Expert modules supported</b>		BMXEHC0200/BMXEHC0800	BMXEHC0200/BMXEHC0800
		BMXERT1604T/H	BMXERT1604T/H
		BMXEAE0300	BMXEAE0300
		BMXETM0200H	BMXETM0200H
			PMESWT0100
<b>Standard services</b>	No	Yes	
	Yes		
	No	Yes	
	No	10 ms	
	No	Yes	
	Yes (media, 50ms recovery time)		
	No		
	■ Input data is collected and published to the remote I/O head adaptor		
	■ Output modules are updated with the data received from remote I/O head adaptor		
	Yes		
	Yes		
	Yes		
	No		
	Yes (Client)		
	Yes (Client)		
	Yes (Agent)		
	Yes (Client)		
	Yes		
	Yes		
<b>Compatibility with processor</b>	Modicon M580 BMEP58●●40(S) Modicon M580 BMEH58●●40(S) Modicon Quantum		Modicon M580 BMEP58●●40(S) Modicon M580 BMEH58●●40(S)
<b>References</b>	<b>BMXCRA31200</b>	<b>BMXCRA31210</b>	<b>BMECRA31210</b>
<b>Page</b>	7/4	7/4	7/4

(1) Not supported in a distant rack in a hot standby configuration

# Modicon X80 module platform

## X80 I/O expansion modules

### Remote I/O drop adapter



BMECRA31210



DIA6ED2151012EN

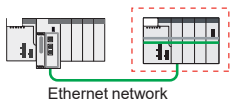

Modicon M580 platform with Modicon X80 RIO drop and adapter

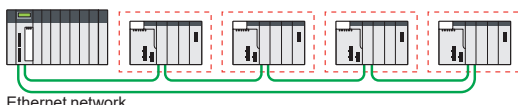

Quantum Ethernet I/O with Modicon X80 RIO drops and adapters

### Modicon X80 Remote I/O drop adapters

#### Offer presentation

A Modicon M580 Ethernet RIO (EIO) architecture with Modicon X80 I/O drops requires the use of Modicon X80 remote I/O drop adapters in each remote rack to connect X80 I/O, communication and expert modules.

The remote I/O drop adapter connects to the RIO network to ensure network determinism on a dedicated private network connected to the Modicon M580 CPU. The X80 modules are integrated and seen by the EcoStruxure Control Expert engineering software as if they were local I/Os, with a high-level of integration in terms of configuration and diagnostics.

Modicon X80 offer comprises three I/O drop adapters:

- Performance drop adapters **BMECRA31210** and **BMXCRA31210**
- Standard drop adapter **BMXCRA31200**

For severe environments, **BM●CRA31210** adapters are also available in a conformal coating version (suffix «C»). See [page 9/3](#) for more details.

#### Adapter compared suitability

According to the considered RIO architecture, each I/O drop adapter presents the most suitable features as shown in the table below:

X80 I/O drop adapter	Communication		Safety		Controllers	
	Ethernet	X-Bus	Safety	Non-Safety	Quantum	M580
<b>BMXCRA31210 (C)</b>		☑		☑	☑	☑
<b>BMXCRA31200</b>		☑	☑	☑	☑	☑
<b>BMECRA31210 (C)</b>	☑	☑	☑	☑		☑

#### Characteristics

##### Connecting I/O drop adapters

Each adapter uses one slot in the Modicon X80 rack and is connected by Ethernet cordsets equipped with RJ45 connectors.

Depending on the distance between the main local rack and remote drops, RIO drop adapters are connected via copper cable (up to 100m) or fiber optic cable (up to 15 km). A DRS switch may be used to extend the distance between devices connected through fiber optic.

##### Supported modules

Depending on model, X80 Remote I/O drop adapters supports various types of modules (1):

- All X80 I/O modules (HART I/O modules only supported by **BMECRA31●10**)
- X80 communication modules (except for **BMXCRA31200**), like Serial link, AS-Interface, PROFIBUS DP, CANopen, and Network option switch modules.
- X80 expert modules (except for **BMXCRA31200**), like counter, time-stamping, SSI encoder, Frequency input, and weighing modules.

##### Redundancy

Redundancy brings service continuity by preventing process downtime and by facilitating reparability and maintenance. For the sake of system redundancy, **BM●CRA312●0** adapters feature a dual Ethernet network connection port that allows daisy chain loop connections using the RSTP protocol (Rapid Spanning Tree Protocol), in a ring topology.

#### References

##### X80 Remote I/O drop adapters

Description	SERVICE port	Device ports	Height mm/in	Reference	Weight kg/lb
X80 RIO drop adapter (Standard)	1	2 (RSTP) RIO Network	100/3.93	<b>BMXCRA31200</b>	0.225/0.49
X80 RIO drop adapters (Performance)	1	2 (RSTP) RIO Network	100/3.93	<b>BMECRA31210</b>	0.225/0.496
		2 (RSTP) RIO Network	100/3.93	<b>BMXCRA31210</b>	0.225/0.496

(1) Please refer to Selection guide [page 7/2](#) for details.

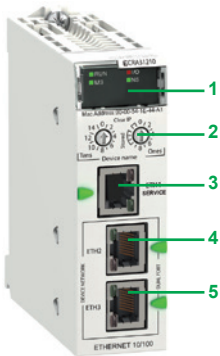

BMECRA31210

#### Modicon X80 Remote I/O drop adapters (continued)

##### Performance Remote I/O drop adapter BMECRA31210

###### Presentation

**BMECRA31210** Performance RIO drop adapter is designed to be installed on an Ethernet backplane in the main remote rack (only one **BMECRA31210** module installed per Modicon X80 RIO drop). This module can also support a

**BMXXBP●●00** expansion rack. **BMECRA31210** adapter features:

- Supports both Ethernet and X-bus communications across the remote backplane.
- Supports Modicon X80 I/Os and TPP partner modules with both Ethernet and X-bus connections (1).
- Support all expert (e.g. counter and weighing modules) and communication (e.g. Serial, PROFIBUS) modules
- Time-stamping can be managed with a resolution of 10 ms for Modicon X80 RIO drops on Ethernet backplane
- Supports CCOTF («change configuration on the fly»)

###### Description

- 1 LED display block indicating the module status
- 2 Rotary switches for setting the address of an EIO drop (00...159)
- 3 Dedicated RJ45 service port (ETH 1) for remote service tools such as a PC, HMI terminal module, or Ethernet DIO devices
- 4 RJ45 device network port (ETH 2) for connection to the Ethernet network
- 5 RJ45 device network port (ETH 3) for connection to the Ethernet network

**Note:** The keying pin on the rear side of the module prevents **BMECRA31210** from being installed on unsupported backplanes.

##### Performance Remote I/O drop adapter BMXCRA31210 (2)

###### Presentation

**BMXCRA31210** Performance RIO drop adapter is designed to be installed on an Ethernet backplane in the main remote rack (only one **BMXCRA31210** module installed per Modicon X80 RIO drop). This module can also support a **BMXXBP●●00** expansion rack. **BMXCRA31210** adapter features:

- Supports X-bus communications only across the remote backplane.
- Supports Modicon X80 I/O and TPP partner modules only with X-bus connections.
- Supports expert (e.g. counter) and communication (e.g. Serial, AS-i) modules only with X-bus connections
- Time-stamping can be managed with a resolution of 10 ms for Modicon X80 RIO drops on an Ethernet backplane
- Supports CCOTF («change configuration on the fly»)

###### Description

- 1 Display block indicating the module status
- 2 Rotary switches for addressing EIO drops (00...159)
- 3 Dedicated RJ45 SERVICE port for remote service tools such as a PC, an HMI terminal, or Ethernet DIO devices (identical to the SERVICE port on Quantum CRP/CRA modules, see [page 2/6](#))
- 4 RJ45 DEVICE NETWORK port for connection to the Ethernet network
- 5 RJ45 DEVICE NETWORK port for connection to the Ethernet network

##### Standard Remote I/O drop adapter BMXCRA31200 (2)

###### Presentation

**BMXCRA31200** Standard RIO drop adapter is a basic adapter designed to be installed on an Ethernet backplane in the main remote rack (only one **BMXCRA31200** module installed per Modicon X80 RIO drop and no expansion rack allowed). **BMXCRA31200** Standard adapter features:

- Supports X-bus communications only across the remote backplane.
- Supports only X80 I/O discrete and analog modules (no support for HART I/O modules), but neither expert nor communication modules.
- No time-stamping, not CCOTF («change configuration on the fly»)

###### Description

- 1 Display block indicating the module status
- 2 Rotary switches for addressing EIO drops (00...159)
- 4 RJ45 DEVICE NETWORK port for connection to the Ethernet network
- 5 RJ45 DEVICE NETWORK port for connection to the Ethernet network

(1) This module is also compatible with X-bus backplanes. In this case it has the same functionality as a **BMXCRA31210** Performance Ethernet drop adapter. For more details, see our website [www.se.com](http://www.se.com).

(2) Also compatible with Quantum PLC

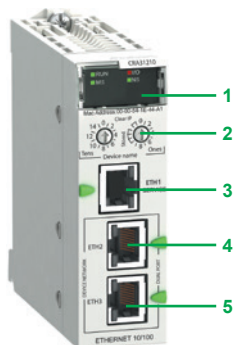

BMXCRA31210

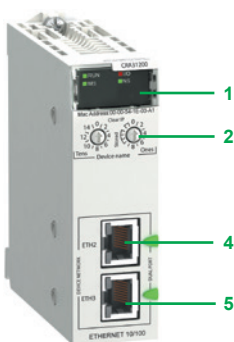

BMXCRA31200

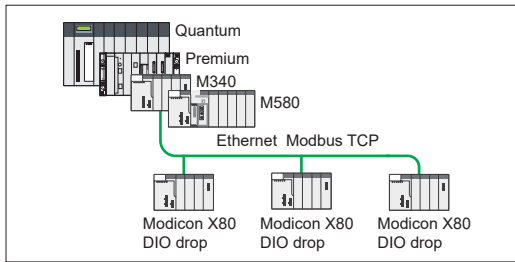

Modicon X80 DIO drops in an Ethernet Modbus TCP network

### Presentation

The **BMXPRA0100** Peripheral remote I/O adapter is dedicated to Modicon X80 DIO drops in a Quantum/Premium/M340/M580 I/O architecture using Ethernet Modbus TCP.

The BMXPRA0100 module manages a remote X80 I/O rack on Ethernet Modbus TCP which includes:

- discrete I/O modules
- analog I/O modules

It communicates by I/O scanning with the master PAC (Quantum/ Premium/M340/ M580).

In case of a redundant Ethernet link, the use of a BMXNOE0100 Ethernet module is required.

### Principal characteristics

#### Primary racks per drop

Up to 4

#### Discrete I/O modules

Up to 1,024

#### Analog I/O modules

Up to 256

#### Internal memory

Up to 448 Kbits

#### Memory card capacity

Up to 96 Kbits

#### Average consumption

95 mA

#### Dissipated power

2.3 W

#### Real time clock with battery backup

Yes

### Description

- 1 Module reference
- 2 Display block indicating the module status
- 3 Memory card port with protective cover
- 4 RJ45 Ethernet port

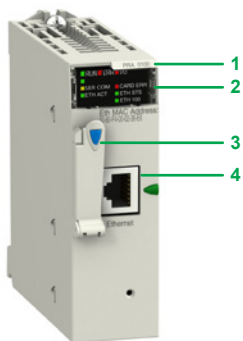

X80 Peripheral remote I/O adapter

# Modicon X80 module platform

## X80 I/O expansion modules

### Peripheral remote I/O adapter

PFI22533A



BMXPRA0100

#### Reference (1)

Description	Reference	Weight kg/lb
<b>X80 Peripheral remote I/O adapter</b> Provides 1 module per Ethernet Modbus TCP DIO drop	<a href="#">BMXPRA0100</a>	—

(1) Requires Unity Pro software ≥ V4.1 or EcoStruxure Control Expert.





---

*Selection guide* ..... page 8/2

**X80 AS-Interface module**

- Presentation, description ..... page 8/4
- Diagnostics, references ..... page 8/5

**X80 Modbus and Character mode serial link module**

- Presentation, description ..... page 8/6
- Characteristics, references ..... page 8/7

**X80 CANopen master module**

- Presentation, description ..... page 8/8
- Diagnostics, references ..... page 8/9

**X80 PROFIBUS DP module**

- Presentation, description, architecture ..... page 8/10
- Software configuration, diagnostics, references ..... page 8/11

**Modbus Plus Proxy**

- Presentation, description ..... page 8/12
- References ..... page 8/13

**X80 Fiber converter modules**

- Presentation, description ..... page 8/14
- References ..... page 8/14

**X80 Ethernet switch module**

- Presentation, description ..... page 8/15
- References ..... page 8/15

\* Communication modules specific to M580 ePAC or M340 PAC are not described in this chapter, please refer to M580 and M340 catalogs.

# Modicon X80 module platform

## X80 communication modules

Applications	AS-Interface communication	Serial link communication	CANopen communication	PROFIBUS communication	Modbus Plus communication
Type of device	AS-Interface module	Modbus and Character mode serial link module	CANopen master module	PROFIBUS DP master module	Modbus plus Proxy



Network protocols	AS-Interface	Modbus and Character mode	CANopen	PROFIBUS DP	Ethernet Modbus TCP	Modbus Plus	
<b>Structure</b>	Physical interface	AS-Interface V3 standard	Non-isolated: RS-232, 8-wire Isolated: RS-485, 2-wire	ISO 11898	RS-485	10/100BASE-TX	RS-485
Type of connector	3-way SUB-D	1xRJ45 and 2XRJ45	9-way SUB-D male	9-way SUB-D female	2 x RJ45	2 x 9-way female SUB-D	2 x 9-way female SUB-D
Access method	Master/slave	–	Master/slave	Master/slave, Token passing	CSMA/CD	HDLC -Token passing	HDLC -Token passing
Data rate	167 Kbps	0.3...115.2 Kbps in RS 232 0.3...57.6 Kbps in RS 485	500 Kbps at 100 m/328 ft 1 Mbps at 20 m/65.62 ft	9.6 kbit/s at 1200 m/3.937 ft 12 Mbit/s at 100 m/328 ft	10/100 Mbps	1 Mbps	1 Mbps
<b>Medium</b>	2-wire AS-Interface cable	Shielded twisted pair copper cable			Double shielded twisted pair copper cable, category CAT 5E (direct or crossover)	Shielded twisted pair copper cable	Shielded twisted pair copper cable
<b>Configuration</b>	Maximum number of devices	62 slaves	2 per drop, 16 per Ethernet remote I/O (RIO) network max.	63 slaves	10 masters, 125 slaves	128	32 per segment 64 for all segments
Maximum length	100 m/328 ft, 500 m/1640 ft max. with 2 repeaters	15 m/49.21 ft with non-isolated RS 232, 1000 m/3280 ft with non-isolated RS 485	100 m/328 ft 2,5 m/8202 ft with repeater	1200 m/3937 ft per segment	100 m/328 ft	450 m/1476 ft per segment 1,8 m/5905 ft with 3 repeaters	
Number of links of the same type per station	<b>BMXP341000</b> processor: 2 AS-Interface modules	20/36 application-specific channels with <b>BMXP341000/P342</b> (1 application-specific channel = 1 counter, motion control, or serial link module channel)	Limitation depends on number of available Ethernet slots in Modicon M580 Local and Remote Racks	Up to 10 <b>PMEPXM0100</b> modules in total with a Modicon M580 <b>BMEP586040</b> processor	1 <b>TCSEGDB23F24FA</b> max.		
	<b>BMXP3420</b> or <b>BMEP58</b> processor: 4 AS-Interface modules	36 application specific channels max. 6 <b>BMXNOM0200</b> modules per <b>BM-CRA31210</b> Ethernet drop adapter (1)	Each <b>BMECXM0100</b> counts as a DIO device. Number of DIO devices depends on CPU/NOC capacity and IO scanner memory				
	<b>BM-CRA31210</b> Ethernet drop adapter: 2 AS-Interface modules	All M580 processors: 36 application-specific channels	–				
<b>Standard services</b>	Transparent exchanges with sensors/actuators	Read/write bits and words, Diagnostics in Modbus mode	Transparent exchanges with CANopen slaves and Ethernet-based processors	Cyclic data exchange (master class1) Acyclic data exchange (master class2)	Modbus/TCP messaging	Modbus Plus messaging	
<b>Conformity class</b>	M4 profile	–	EDS description files of the slaves	PI International certified	–	–	
<b>Communication services</b>	Gateway DTM	No	Yes	Yes	No	No	No
FDR Service	No	No	Yes	Yes	Yes	No	No
SNMP Network Management	No	No	Yes (Agent)	Yes (Agent)	Yes (Agent)	No	No
Syslog	No	No	Yes (Client)	Yes (Client)	No	No	No
Modbus Plus server	No	No	No	No	Yes (scanned by the PLC)	No	No
Read/Write variables	No	No	No	No	No	Yes	Yes
Global Data	No	No	No	No	No	Yes	Yes
Peer Cop service	No	No	No	No	No	Yes	Yes
<b>Compatibility with processor</b>	Modicon M340, Modicon M580		Modicon M580 only		Modicon M340, Modicon M580		
<b>References</b>	<b>BMXEIA0100</b>	<b>BMXNOM0200</b>	<b>BMECXM0100</b>	<b>PMEPXM0100</b>	<b>TCSEGDB23F24FA</b>		
<b>Page</b>	8/5	8/6	8/8	8/10	8/12		

(1) Only BMXNOM0200



#### Presentation

The **BMXEIA0100** master module for AS-Interface cabling system provides the AS-Interface system master function for the Modicon X80 module platform.

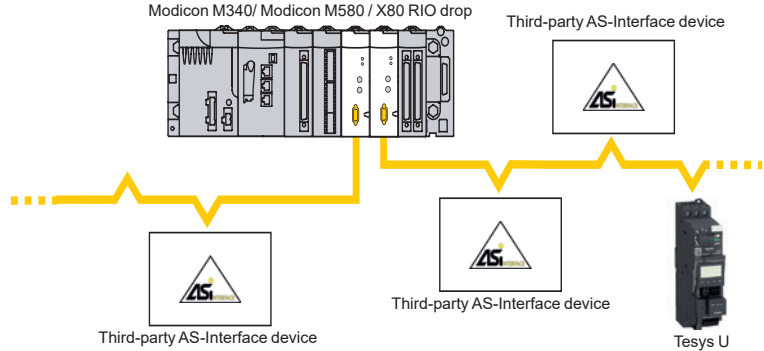

The AS-Interface cabling system consists of a master station (Modicon X80 module platform) and slave stations. The master supporting the AS-Interface profile interrogates the devices connected on the AS-Interface line one-by-one and stores the information (actuator/sensor status, device operating status) in the PLC memory. Communication on the AS-Interface line is managed totally transparently in relation to the application PLC program.

The **BMXEIA0100** module supports the latest management profile for AS-Interface devices (*AS-Interface V3*), which is able to manage level V1, V2, and V3 AS-Interface slaves:

- Discrete slave devices (up to 62 devices of 4 inputs/4 outputs organized in 2 banks (A/B) of 31 addresses each)
- Analog devices (up to 31 devices (4 channels) in bank A)
- Safety interfaces (up to 31 devices in bank A)

An AS-Interface power supply is essential for powering the various devices on the line. Ideally it should be placed near stations that consume a great deal of energy. Please refer to the “Phaseo AS-i ABL Single phase power supplies 2.4 and 4.8 A for AS-Interface wiring system” catalog.

A Modicon M340 Performance configuration with a **BMXP3420●0/20●02** processor or a Modicon M580 configuration with a **BMEP58●●●●** processor can take 4 **BMXEIA0100** modules. A Standard configuration with **BMXP341000** processor can take 2 **BMXEIA0100** modules.

#### Description

The **BMXEIA0100** AS-Interface master module is standard format (1 slot). Its housing provides IP20 protection of the electronics and it is locked into each rack slot (**01 ...11**) by a captive screw.

The front panel of the **BMXEIA0100** AS-Interface master module features:

- 1 A rigid body providing support and protection for the electronic card
- 2 A module reference marking
- 3 A display block with 5 LEDs indicating the module operating modes:
  - RUN (green): Module running
  - ERR (red): Detected module fault
  - A/B (green): Displays the group of 31 slaves
  - I/O (red): Detected I/O fault on AS-Interface line
  - 32 LEDs for diagnostics of the AS-Interface line and each slave connected on the line depending on the A/B pushbutton selection (1)
- 4 2 LEDs marked ASI POWER and FAULT: AS-Interface external power supply present and detected AS-Interface line fault (see diagnostics on [page 8/5](#))
- 5 Two pushbuttons marked A/B and MODE (see diagnostics on [page 8/5](#))
- 6 A 3-way male SUB-D connector for the AS-Interface cable (female screw clamp connector supplied)

(1) Depending on whether A or B is selected, this displays either the first 31 slaves (standard addressing) or the last 31 slaves (extended addressing).

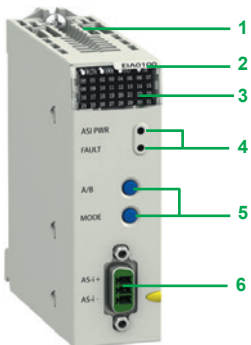

BMXEIA0100



Rack function display in Web browser

### Diagnostics

The two LEDs **4** on the module front panel are used in conjunction with the two pushbuttons **5** for module diagnostics:

LEDs		Pushbuttons	
<b>4</b> ASI PWR: AS-Interface power supply present	<b>4</b> FAULT: Detected AS-Interface line fault	<b>5</b> A/B: Selects the group of slaves on the display block <b>3</b>	<b>5</b> MODE: Module Offline/Online

The display block on the front panel of the **BMXEIA0100** master module can be used to perform simplified local diagnostics by displaying the slave devices present on the AS-Interface line.

Detailed diagnostics of each slave device is also possible using:

- An adjustment terminal (1)
- A Web browser using the Rack Viewer function in the standard Web server on the Modicon X80 module platform. For further information, please consult our website [www.se.com](http://www.se.com).

### References

#### X80 AS-Interface module

Description	Usage	Reference	Weight kg/lb
<b>AS-Interface master module</b> supplied with 3-way male SUB-D connector	M4 AS-Interface profile for level V1, V2, and V3 slaves	<a href="#">BMXEIA0100</a>	0.340/ 0.750

(1) For instance, see our [Bihl+Wiedemann partner offer](#).



#### Presentation

The Modbus serial link is used for client/server architectures (it is necessary, however, to check that the Modbus services used by the application have been implemented on all relevant devices).

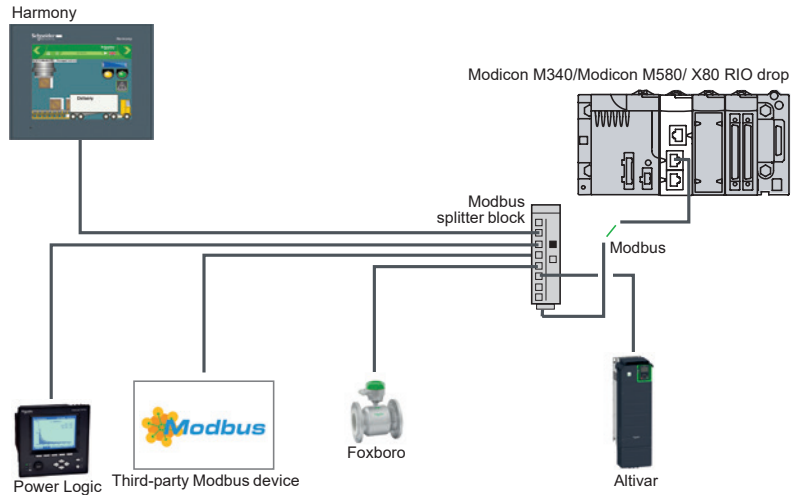

The bus consists of a client station and server stations. Only the client station can initiate the exchange (direct communication between server stations is not possible). Two exchange mechanisms are available:

- Question/response, where requests from the client are addressed to a given server. The client then waits for the response from the server that has been interrogated.
- Broadcasting, where the client broadcasts a message to all server stations on the bus. The latter execute the order without transmitting a reply.
- It is necessary to use **BM•CRA31210** modules as drop adapters. On one drop it is possible to plug a maximum of two **BMXNOM0200** modules.

The following services are not available in the server stations:

- Modbus server
- Modem services

Although most processors have a serial link that can support modems, the **BMXNOM0200** 2-channel serial link module is particularly recommended for this type of use.

Its performance and numerous parameter-setting options make it ideal for any type of configuration, especially when using radio modems.

#### Description

##### X80 serial link module

The front panel of the **BMXNOM0200** serial link module features:

- 1 A screw for locking the module in a slot in the rack
- 2 A display block with 4 LEDs:
  - RUN (green) and ERR (red): Module status
  - For each of the two channels: SER COM (green): Activity on the serial link (lit/ detected fault on a device present on the serial link (flashing)
- 3 Two RJ45 connectors (exclusive use) for connection of channel 0 (with black indicator):
  - 3a A connector for RS 232C connection, marked COM Port 0 RS232
  - 3b A connector for RS 485 connection, marked COM Port 0 RS485
- 4 An RJ45 connector for RS 485 connection of channel 1, marked COM Port 1 RS485, with black indicator

##### To be ordered separately:

RS 485 cordsets (refer to the "Modicon M580 automation platform" catalog available on our website [www.se.com](http://www.se.com)) or RS 232 cordsets for DCE terminal (see [page 8/7](#)).

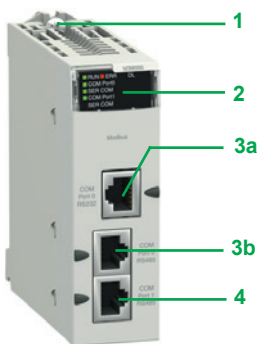

BMXNOM0200



EcoStruxure Control Expert monitor



BMXNOM0200



DIA6ED2151012EN

#### Complementary characteristics

The following characteristics complement those indicated in the selection guide on [page 8/9](#).

#### BMXNOM0200 module serial links

- Physical interface:
  - RS 232 port 0: RS 232 8-wire, non-isolated
  - RS 485 port 0 and port 1: RS 485 2-wire, isolated
- Frame:
  - Modbus: RTU/ASCII, full duplex in RS 232, half duplex in RS 485
  - Character mode: full duplex in RS 232, half duplex in RS 485
- Data rate:
  - RS 232 port 0: 0.3...115 Kbps (Modbus/Character mode)
  - RS 485 port 0 and port 1: 0.3...57.6 Kbps (Modbus/Character mode)
- Line polarization:
  - Modbus RS 485: automatic
  - RS 485 character mode: configurable with EcoStruxure Control Expert (1) software
    - Maximum length of a tap link in RS 485 2-wire:
      - 15 m/49 ft in a non-isolated link
      - 40 m/131 ft in an isolated link
- Expert mode (from version V1.2 of the module and version V5 of Unity Pro (1): used to configure the time out links individually from the application and thus adapt to the specific characteristics of certain modems.

#### References (2)

##### X80 Serial link module

Description	Protocol	Physical layer	Reference	Weight kg/lb
<b>2-channel serial link module (3)</b>	Modbus client/server RTU/ASCII, Character mode, GSM/GPRS modem	1 non-isolated RS 232 channel (Port 0) 2 isolated RS 485 channels (Port 0 and Port 1)	<b>BMXNOM0200</b>	0.230/ 0.507

##### Cordsets for RS 232 serial link (4)

Description	Connexion	Number of wires	Length m/ft	Reference	Weight kg/lb
<b>Cordset for Data Terminal Equipment (DTE)</b> (printer)	RJ45 connector and 9-way female SUB-D connector		3/ 9.84	<b>TCSMCN3M4F3C2</b>	0.150/ 0.331
<b>Cordset for Data Communication Equipment (DCE)</b> (modem, etc.)	RJ45 connector and 9-way female SUB-D connector	4-wire (RX, TX, RTS, CTS) 8-wire (excluding RI signal)	3/ 9.84	<b>TCSMCN3M4M3S2</b> <b>TCSXCN3M4F3S4</b>	0.150/ 0.331 0.165/ 0.364

(1) EcoStruxure Control Expert software continues the Unity Pro range of software and corresponds to versions  $\geq 14$  of Unity Pro.

(2) Requires Unity Pro software  $\geq V1.4$ .

(3) For the ruggedized version, **BMXNOM0200H**, see characteristics on [page 9/9](#).

(4) RS 485 serial link connection (refer to the "Modicon M580 automation platform" catalog available on our website [www.se.com](http://www.se.com)).

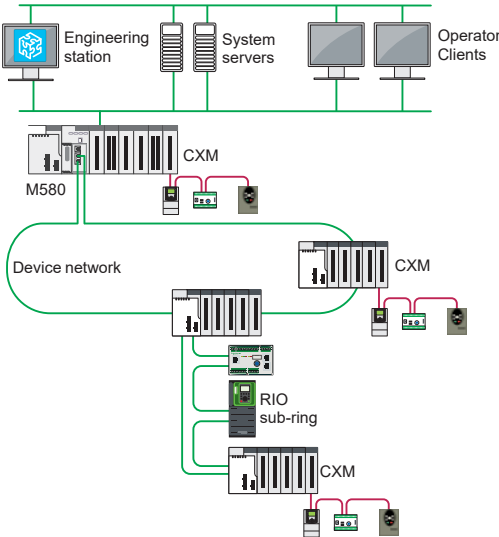

Typical topology to connect CANopen devices to M580/X80 platforms with BMECXM0100

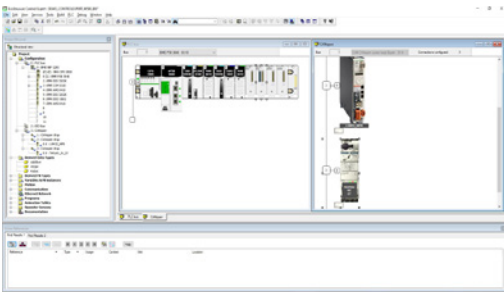

Configuring CANopen with EcoStruxure Control Expert

### Presentation

CANopen is an open network supported by more than 600 companies worldwide, and promoted by CAN in Automation (CiA). With the general acceptance of CANopen, Schneider Electric has the accumulated and proven experience of applying CANopen in machine solution platforms.

CANopen helps to ensure reliable and deterministic access to real-time data in field devices. As a consequence, products using CANopen are increasingly used in control system architectures. The **BMECXM0100** CANopen master module provides powerful access to the CANopen slaves from the M580 local rack or a remote X80 drop.

### Advantages

**BMECXM0100** is designed to fulfill customer needs by offering the following advantages:

- Operational intelligence:
  - Complete software integration into Unity with a predefined catalog of preferred devices and numerous automated operations such as device variable creation, IP/DHCP settings, and IO scanner configuration
  - Simple integration of third-party devices
- Maintenance excellence:
  - Robust and well-designed with a long life cycle following X80 standards
  - Built to withstand extreme temperatures (-25 °C to +70 °C/-13 °F to +158 °F), ATEX certified
  - Easy diagnostics by maintenance engineers via a simple Web browser (no need for Unity) and the FDR (Fast Device Replacement) service
- Investment protection: Totally flexible topologies with the possibility of using several **BMECXM0100** modules in a single M580, or in a remote I/O drop closest to the process
- Time-to-market: Simple, compact size, all in one, which reduces installation time
- Enhanced protection and security: Integrated cybersecurity design helps to protect plant operations

### Description

The **BMECXM0100** CANopen X80 master module is standard format (1 slot) and supports one CANopen port (SUB-D9 male connector).

The **BMECXM0100** supports up to 63 slaves with a maximum process image size of 4 Kbytes IN/4 Kbytes OUT.

Standardized baudrates between 20 Kbd and 1 Mbd (20 Kbd, 50 Kbd, 125 Kbd, 250 Kbd, 500 Kbd, 1 Mbd) are supported.

Depending on the performance level required by the process, the **BMECXM0100** module can be scanned by the RIO or the DIO scanner of the M580 CPU. RIO scanning helps to ensure optimum performance, in sync with the PLC task (MAST, FAST or AUX).

Several BMECXM modules can be connected to the same or different I/O scanners in the same M580 PAC.

**BMECXM0100** modules are not compatible with redundant M580 architectures, and cannot be scanned by an Ethernet module including **BMENOC03•1** and **BMXNOC0402**.

Third-party CANopen slaves can only be configured in **BMECXM0100** modules from their EDS description files and via the hardware catalog manager. They cannot be configured from their DTM. Communication between the device and its DTM over Ethernet IO is also not supported.



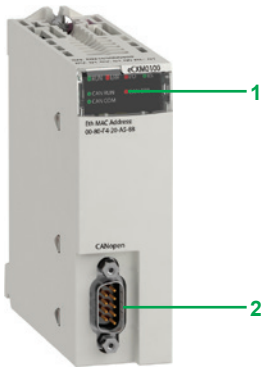

BMECXM0100

#### Diagnostics

The 5 LEDs **1** on the module front panel are used for quick CANopen communication diagnostics:

LED	Color	Description
I/O	Red	Indicates the exchange status with CANopen devices
BS (Bus Status)	Red/Green	Indicates the EtherNet/IP connection status
	Yellow	Firmware upgrade in progress
CAN RUN	Green	Indicates the status of the CANopen fieldbus
CAN ERR	Red	Indicates the status of the CANopen physical layer and indicates detected errors due to missing CAN messages (SYNC, node-guarding, or heartbeat)
CAN COM	Yellow	Dedicated to SDO transmission

#### References

##### X80 CANopen master module

Description	Reference	Weight kg/lb
Communication module used in M580/X80 Ethernet platform; supplied with male 9-way SUB-D connector <b>2</b>	<a href="#">BMECXM0100</a> (1)	–

(1) For the "Conformal coating" version BMECXM0100H, see [page 9/9](#).



PMEPXM0100 PROSOFT partner PROFIBUS module

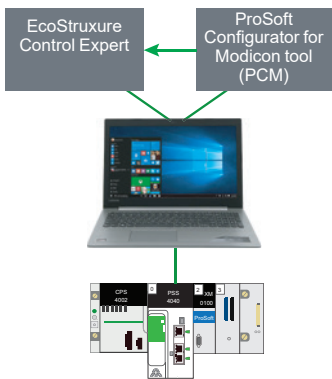

Interaction between EcoStruxure Control Expert, Prosoft Configurator for Modicon (PCM tool), and X80 PROFIBUS DP module

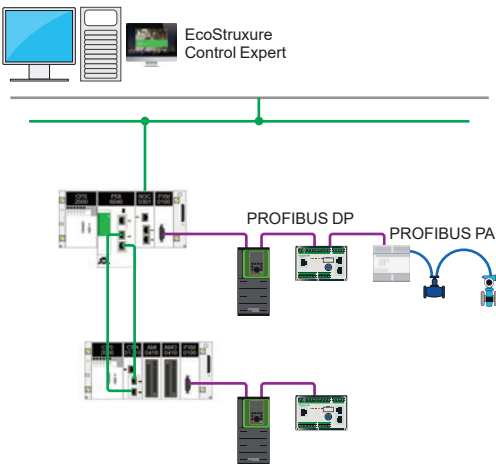

Standalone topology to connect X80 PROFIBUS DP module to M580/X80 platforms with PMEPM0100

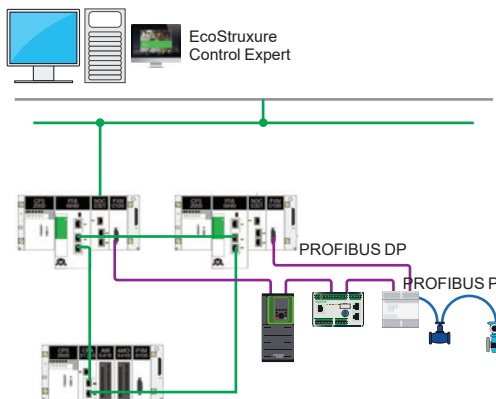

Redundant (HSBY) topology to connect the PROFIBUS DP master X80 module to M580/X80 platforms with PMEPM0100

## Presentation

### Overview

The X80 PROFIBUS DP module allows the user to integrate PROFIBUS DP slave devices into Schneider Electric M580 control system to exchange process, alarming, and diagnostic data with PROFIBUS DP devices as well as to provide configuration and asset management of slave devices using Device Type Managers (DTMs).

This is an advanced in-rack solution for your PROFIBUS system compliant with Hot Standby (HSBY) and Standalone common Safety architectures.

New versions of M580 CPU and BMECRA31210 X80 Remote I/O drop adapter firmware and software are necessary to operate the module:

- CPU version  $\geq$  V2.80
- BMECRA31210 version  $\geq$  V2.40 if the module is used in a remote drop
- EcoStruxure Control Expert  $\geq$  V14
- ProSoft Configurator for Modicon tool (PCM)

### Advantages

The X80 PROFIBUS DP module is designed to meet customer needs by offering the following advantages:

- High performance, with up to 125 slave devices behind one module (2 Kb IN/2 Kb OUT), and up to 10 PROFIBUS masters in one M580 configuration
- Real-time PROFIBUS network analyzer with packet capture tool: accelerates the troubleshooting phase, fine tunes network options, and anticipates any maintenance needs
- Simple and ergonomic ProSoft Configurator for Modicon (PCM) with easy import into EcoStruxure Control Expert to efficiently build the PROFIBUS architecture
- Easy modernization from Quantum PTQ, user-friendly interface
- Achilles Level 2, HTTP, SNMP, Access control & Sys Log

## Description

X80 PROFIBUS DP module is a PROFIBUS DP V1 master class 2 module that can be plugged in the M580 local rack or in any remote drop supporting the M580 Ethernet backplane depending on the architecture. It has an Autoscan feature to automatically poll and configure all the active slaves connected to the bus.

The PROFIBUS Communication DTM library is provided to enable the module interface by PROFIBUS Asset Management Tools.

“On the fly” operations, such as changing parameters or adding a new device online, are allowed.

The module is refreshed based on the RPI values, asynchronous to the periodic tasks. This refreshment is achieved via the Mast task with limited impact on the task duration, which is proportional to the device number.

The X80 PROFIBUS DP module can be scanned by the M580 CPU as well as by any Ethernet module (BMENOC●●●●). Nevertheless, the CPU capacity (mainly memory) is designed to be capable of managing all X80 PROFIBUS DP modules installed in the configuration. This simplifies the architecture and the process of modifying slave parameters via the “on the fly” feature, as well as that of adding new devices.

An advanced operating mode provides the option to stop the module while the PLC is in RUN in order to manage any modification without stopping the process.

## Architecture

The X80 PROFIBUS DP module can be integrated into two types of architecture:

- Standalone:
  - Local racks and remote racks
  - Up to 6 modules in one configuration for high-end M580 CPU
  - Common Safety
- Redundant (HSBY):
  - Local rack only
  - Up to 6 modules in each rack for high-end M580 CPU



ProSoft Configurator for Modicon tool (PCM)

### ProSoft Configurator for Modicon tool (PCM)

The following are required to configure the **PMEPXM0100** X80 PROFIBUS DP module:

- EcoStruxure Control Expert V14 and higher
- ControlExpert\_V140\_HF\_PMEPXM0100
- ProSoft Configurator for Modicon tool (PCM)

There is a strong interaction between EcoStruxure Control Expert and the Prosoft Configurator for Modicon (PCM). The ProSoft Configurator for Modicon tool (PCM) also provides the finest level of information and diagnostics on the module, on the bus, and on all the slaves. This tool is available at no additional cost on the Schneider Electric website in the product page section.

The PROFIBUS DP module is integrated from EcoStruxure Control Expert with high-level services:

- It is included natively in the EcoStruxure Control Expert (1) hardware catalog
- Exhaustive Device DDT for advanced control and diagnostics

Index	Time	Dir	Status	Src	Dest	Function	Details	Src SAP	Dest SAP	FDU	Data	
0	0.327093	Rx	Ok	8	1	Response	Data	-	-	00:00:00	68:07:07:68:01:0...	
1	0.331732	Tx	Ok	1	2	Request	SRD - Priority	-	-	02:03	68:05:05:68:02:0...	
2	0.368113	Rx	Ok	2	1	Response	Data	-	-	03:00:00:03	68:05:05:68:01:0...	
3	0.372757	Tx	Ok	1	1	Token	-	-	-	-	0C:01:01	0C:01:01
4	0.384423	Tx	Ok	1	1	Token	-	-	-	-	0C:01:01	0C:01:01
5	0.396044	Tx	Ok	1	1	Token	-	-	-	-	0C:01:01	0C:01:01
6	0.407684	Tx	Ok	1	1	Token	-	-	-	-	0C:01:01	0C:01:01
7	0.419322	Tx	Ok	1	8	Request	SRD - Priority	-	-	00	68:04:04:68:08:0...	
8	0.432843	Rx	Ok	8	1	Response	Data	-	-	00:00:00	68:07:07:68:01:0...	
9	0.457481	Tx	Ok	1	2	Request	SRD - Priority	-	-	02:03	68:05:05:68:02:0...	
10	0.463963	Rx	Ok	2	1	Response	Data	-	-	03:00:00:03	68:05:05:68:01:0...	
11	0.486925	Tx	Ok	1	6	Request	Request FDU Stat.	-	-	-	00:00:01:48:50:90	00:00:01:48:50:90
12	0.519374	Tx	Ok	1	1	Token	-	-	-	-	0C:01:01	0C:01:01
13	0.531013	Tx	Ok	1	8	Request	SRD - Priority	-	-	00	68:04:04:68:08:0...	
14	0.544553	Rx	Ok	8	1	Response	Data	-	-	00:00:00	68:07:07:68:01:0...	
15	0.568231	Tx	Ok	1	2	Request	SRD - Priority	-	-	02:03	68:05:05:68:02:0...	
16	0.605613	Rx	Ok	2	1	Response	Data	-	-	03:00:02:03	68:05:05:68:01:0...	
17	0.610258	Tx	Ok	1	1	Token	-	-	-	-	0C:01:01	0C:01:01
18	0.627623	Tx	Ok	1	1	Token	-	-	-	-	0C:01:01	0C:01:01
19	0.632544	Tx	Ok	1	1	Token	-	-	-	-	0C:01:01	0C:01:01
20	0.648184	Tx	Ok	1	1	Token	-	-	-	-	0C:01:01	0C:01:01
21	0.698823	Tx	Ok	1	8	Request	SRD - Priority	-	-	00	68:04:04:68:08:0...	
22	0.690343	Rx	Ok	8	1	Response	Data	-	-	00:00:00	68:07:07:68:01:0...	
23	0.694980	Tx	Ok	1	2	Request	SRD - Priority	-	-	02:03	68:05:05:68:02:0...	
24	0.731363	Rx	Ok	2	1	Response	Data	-	-	03:00:02:03	68:05:05:68:01:0...	

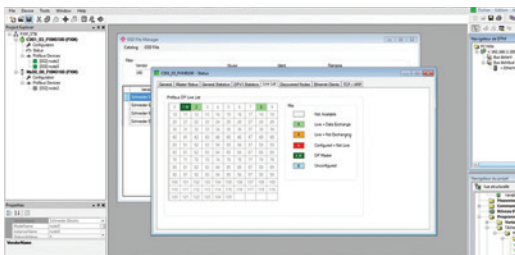

PMEPM0100 status monitoring - Live List



PMEPM0100

### Diagnostics and monitoring

The 7 LEDs on the module front panel are used for quick PROFIBUS DP fieldbus communication diagnostics.

The X80 PROFIBUS DP module provides a range of statistics that can assist with module operation, maintenance, and fault finding. The statistics can be accessed by the Prosoft Configurator for Modicon or via the Web server embedded in the module.

### References

#### X80 PROFIBUS DP module

Description	Reference	Weight kg/lb
Used for M580 platform fieldbus communication	<a href="#">PMEPM0100</a>	0.270/ 0.595



(1) EcoStruxure Control Expert software continues the Unity Pro range of software and corresponds to versions ≥ 14 of Unity Pro.

# Modicon X80 module platform

## X80 Communication modules

### Modbus Plus Proxy

#### Presentation

The **TCSEGDB23F24FA** Modbus Plus Proxy module is a network gateway that allows Modicon M340 and M580 PLCs to communicate with existing Modbus Plus devices.

It is not necessary to modify the applications for these devices to communicate with the Modicon M340 and M580 PLCs, since the module automatically addresses the platforms and the various communication functions between the M340/M580 and other PLC platforms (especially 984LL).

The Modbus Plus Proxy offers Modbus Plus PLC users the chance to integrate M340 and M580 PLCs easily into their Modbus Plus network and thus to access advanced communications via Ethernet, or to migrate gradually from other PLC models to Modicon M340/M580 and EcoStruxure Control Expert (1).

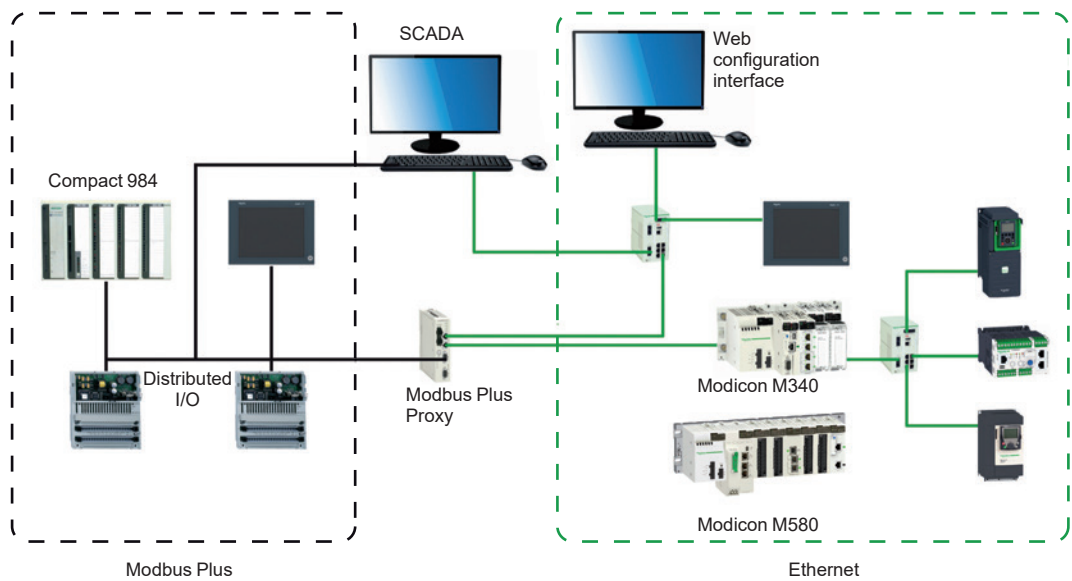

#### Key benefits

##### Reduced startup time

- Online configuration of the proxy via a simple Web browser
- Web page setup similar to the screens of the Modbus Plus Peer Cop utility, accessible under Concept/EcoStruxure Control Expert (1) for the Global Data transaction
- Simpler data exchange with Global Data transactions performed on all network nodes
- Point-to-point communication without programming with Peer Cop

##### Increased network reliability and maintainability

- Standard diagnostics provide data on all network nodes for easy troubleshooting
- Dual Modbus Plus ports provide Modbus Plus network redundancy

##### Reduced total cost of ownership

- Helps protect your investment in Modbus Plus while migrating to Ethernet
- Dual Ethernet ports allow connection of both the M340 or M580 PLC and the configuration PC to the proxy, without any additional switches

(1) Unity Pro software in earlier versions.

# Modicon X80 module platform

## X80 Communication modules

### Modbus Plus Proxy



#### Embedded Web server

##### Web server functions

The Modbus Plus Proxy includes an embedded Web server that can be used to perform diagnostics and configure the module connection. Data is presented in the form of standard web pages in HTML format. To access a web page, you need Internet Explorer (version 6.0 or later) and Java (version 1.5 or later).

##### Embedded Web server functions

- 1 - Setup: The Setup pages allow you to define the parameters for several different module services, including security, IP, SNMP, Global Data, Peer Cop, and Ethernet ports.
- 2 - Diagnostics: These network diagnostic pages contain Ethernet, TCP, and SNMP statistics, as well as a log of the diagnostics performed.

#### Complementary characteristics

The following characteristics complement those introduced in the communication selection guide on [page 8/2](#):

- External power supply voltage: 19.2...31.2 V ---
- Consumption: 300 mA max.
- Dissipated power: 6.2 W



TCSEGB23F24FA

#### References

##### System and network requirements

- EcoStruxure Control Expert or Unity Pro XL programming software (version 3.x or later) (1)
- Internet Explorer (version 6.0 or later)
- Java (version 1.5 or later)
- Microsoft Windows XP or Vista

##### Modicon M340 processors:

- BMXP342020 (Modbus and Ethernet version)
- BMXP3420302 (CANopen and Ethernet version)
- BMXP3420302CL (CANopen and Ethernet version) (2)

##### Modicon M580 processors:

- BMEP581020
- BMEP582020/BMEP582040(S)
- BMEP583020/BMEP583040
- BMEP584020/BMEP584040(S)
- BMEP585040
- BMEP586040(S)

##### Modicon M340 Ethernet modules:

- BMXNOE0100
- BMXNOE0110
- BMXNOC0401

##### Modicon M580 Ethernet modules:

- BMENOC0301
- BMENOC0311
- BMENOC0321

##### Modicon Modbus Plus Proxy (3)

Description	Supplied with	Reference	Weight kg
Modbus Plus Proxy module for Modicon M340 and M580 PLCs	2 front-mounted power supply connectors (2 positions)	<a href="#">TCSEGB23F24FA</a>	—

(1) Unity V8.0 or later with M580  
 (2) Memory card to be ordered separately for the **BMXP3420302CL** processor (see our website [www.se.com](http://www.se.com)).  
 (3) For Modicon Modbus Plus Proxy with conformal coating, see [page 9/9](#).

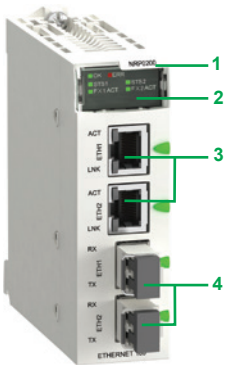

BMXNRP020

#### Modicon X80 Fiber converter module (1) (2)

##### Presentation

**BMXNRP0200/0201** module offers an alternative to the use of Modicon managed dual ring switches (DRS), for fiber optic communications over long distances in Ethernet I/O systems (RIO or DIO).

When inserted in Modicon X80 EIO drops, **BMXNRP0200/0201** modules make it possible to:

- Extend the total distance of the EIO network when EIO drops are located in areas of the factory above 100 m/328 ft
- Enhance immunity to noise
- Resolve grounding incompatibilities between sites with different grounding methods

**BMXNRP0200/0201** modules can be installed on the primary or secondary rings. These modules cannot, however, be used to connect secondary rings to the primary ring.

Following the distance of the remote location, you may select:

- The **BMXNRP0200** module for multimode optical fiber which allows remote location up to 2 km/1.25 mi., or
- The **BMXNRP0201** module for single-mode optical fiber which allows remote location up to 16 km/9.94 mi.

Depending on the configuration, the X80 Fiber converter module may be linked to the X80 Remote I/O drop adapter of the drop where it is installed, via 1 or 2 Ethernet Interlink cables.

##### Description

- 1 Module reference
- 2 Display block indicating the module status
- 3 RJ45 Ethernet ports (2 LEDs, LNK and ACT, indicate the status of each port)
- 4 Fiber optic ports with SFP transceiver for LC type connector

Instead of embedded switch, you may also use our external Modicon Switch described in the Modicon Switch catalog. They are all delivered with predefined parameters in order to optimize your architecture performances such as dual ring switch, management of main ring RIO, sub-ring or loop with DIO.



DIA6ED2140903EN

##### References (1)

##### X80 Fiber converter modules (2)

Description	Optical fiber	Reference	Weight kg/lb
Modules for fiber optic communications over long distances	Multimode	<a href="#">BMXNRP0200</a>	–
	Single-mode	<a href="#">BMXNRP0201</a>	–

(1) For additional characteristics, see our website [www.se.com](http://www.se.com).

(2) Requires Unity Pro Extra Large software ≥ V7.0 or EcoStruxure Control Expert: see our website [www.se.com](http://www.se.com).

# Modicon X80 module platform

## X80 Communication modules

### Ethernet switch module

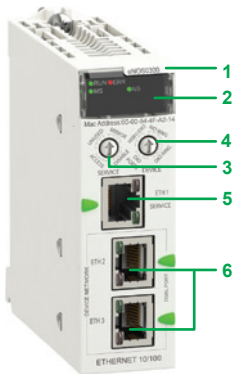

BMENOS0300



DIA6ED2140903EN

### Ethernet switch module

#### Presentation

The **BMENOS0300** Ethernet switch module offers an economic alternative to the use of Modicon managed dual ring switches (DRS) for copper Ethernet communication over short distances in Ethernet I/O systems (RIO or DIO). Based on the rotary switches on the front panel, the application of the 2 device network ports can be configured intuitively as:

- RIO ring
- DIO ring
- DIO ports

Depending on the architecture, the **BMENOS0300** switch can be used to communicate with the distributed I/O by simply inserting it in the local main rack or remote drops.

#### Description

- 1 Module reference
- 2 Display block indicating the module status
- 3 Rotary switch for configuring the ETH 1 service port
- 4 Rotary switch for configuring the 2 device network ports (ETH 2 and ETH 3)
- 5 ETH 1: Service port (Ethernet)
- 6 ETH 2/ ETH 3: Device network port (Ethernet)

Instead of embedded switch, you may also use our external Modicon Switch described in the Modicon Switch catalog. They are all delivered with predefined parameters in order to optimize your architecture performances such as dual ring switch, management of main ring RIO, sub-ring or loop with DIO.

### References (1)

#### X80 Ethernet switch module

Description	SERVICE port	Device network port (Ethernet)	Reference	Weight kg/lb
Switch for copper Ethernet communication over short distances	1	2	<b>BMENOS0300</b>	–

(1) For additional characteristics, see our website [www.se.com](http://www.se.com).





# 9 - Dedicated parts for severe environments

---

## Treatment for severe environments

- **Presentation** ..... [page 9/2](#)
- Protective treatment for Modicon X80 module platform ..... [page 9/2](#)
- Treatment for severe environments ..... [page 9/2](#)
  - Harsh chemical environments ..... [page 9/2](#)
  - Extreme climate environments ..... [page 9/2](#)
- Specific characteristics for Safety modules ..... [page 9/3](#)
- X80 offer for severe environments composition ..... [page 9/3](#)

## Dedicated parts for severe environments

- **X80 Racks and rack expansion module for severe environments**
- References ..... [page 9/4](#)
- **X80 Power supplies for severe environments**
- References ..... [page 9/5](#)
- **X80 I/O modules for severe environments**
- X80 Discrete I/O modules ..... [page 9/6](#)
- X80 Analog I/O modules ..... [page 9/7](#)
- **X80 Expert modules for severe environments**
- X80 Counter modules ..... [page 9/8](#)
- X80 Time-stamping module ..... [page 9/8](#)
- X80 SSI encoder interface module ..... [page 9/8](#)
- X80 Frequency input module ..... [page 9/8](#)
- **X80 I/O expansion modules for severe environments**
- X80 Remote I/O drop adapter with conformal coating ..... [page 9/9](#)
- **X80 Communication modules for severe environments**
- X80 Modbus and Character mode serial link module ..... [page 9/9](#)
- X80 CANopen master module ..... [page 9/9](#)
- X80 PROFIBUS DP module ..... [page 9/9](#)
- X80 PROFIBUS DP network gateway ..... [page 9/9](#)
- X80 Fiber converter modules ..... [page 9/9](#)
- X80 Ethernet switch module ..... [page 9/9](#)



### Presentation

#### Protective treatment for Modicon X80 module platform

The Modicon X80 module platform complies with “TC” treatment requirements (treatment for all climates). It is designed as standard to operate in temperatures ranging from 0 to +60 °C/32 to 140 °F.

For installations in industrial environments corresponding to “TH” (treatment for hot and humid environments), devices must be housed in enclosures providing at least IP54 protection as specified by standard IEC/EN 60529, or an equivalent level of protection according to NEMA 250.

The Modicon X80 module platform offers **IP20 protection** (1). It can therefore be installed within an enclosure in reserved access areas that do not exceed **pollution level 2** (control room with no conductive dust). **Pollution level 2** does not take account of harsher environments, such as those where the air is polluted with conductive dust, fumes, corrosive or radioactive particles, vapors or salts, molds, insects, etc. All the safety hardware in-rack modules colored red (processor, coprocessor, X80 I/O) are conformal coated for use in severe environments.

#### Treatment for severe environments

If the Modicon X80 module platform has to be used in more severe environments or is required to start and operate in an extended temperature range, from **-25 °C to +70 °C/-13 °F to 158 °F** (only H or T version), the “**ruggedized**” offer features industrially hardened processor and power supply modules, X-bus and Ethernet I/O modules and racks that have a protective coating on their circuit boards.

*Note: Capable of starting within an extended temperature range (from -25 °C to +70 °C/-13 °F to 158 °F, a single-rack configuration is also able to operate at extremely low temperatures (as low as -40 °C/-40 °F) if placed in an appropriate enclosure. Please contact our Customer Care Center.*

The coated/harsh offer provides the Safety CPU/coprocessor and Safety I/O modules with “AVR 80” coating on their electronic cards. This treatment increases the isolation capability of the circuit boards and their resistance to:

- Condensation
- Dusty atmospheres (conducting foreign particles)
- Chemical corrosion, in particular during use in sulfurous atmospheres (oil refinery, purification plant, etc.) or atmospheres containing halogens (chlorine, etc.) or chemical vapors

This protection, combined with appropriate installation and maintenance, enables Modicon X80 platform products to be used in the following environments:

#### Harsh chemical environments (products with suffix ‘H’ and ‘C’)

The use of contact grease protection on connectors, removal blocks is mandatory to meet these requirements.

The lubricant protection seals electrical contacts from oxygen, moisture, aggressive gasses, and other hostile elements.

- **IEC/EN 60721-3-3 class 3C1, 3C2, 3C3, 3C4:**
  - 7 days; 25 °C/77 °F relative humidity 75%
  - Concentrations (ppb): H<sub>2</sub>S: 9,900/SO<sub>2</sub>: 4,800/Cl<sub>2</sub>: 200
- **ISA S71.04 classes G1, G2, G3, Gx:**
  - 14 days; 25 °C/77 °F relative humidity 75%
  - Concentrations (ppb): H<sub>2</sub>S: 60/SO<sub>2</sub>: 350/Cl<sub>2</sub>: 1,450/NO<sub>2</sub>: 12
- **IEC/EN 60068-2-52 salt mist, Kb test severity level 2:**
  - 3 x 24-hour cycles
  - 5% NaCl
  - 40 °C/104 °F relative humidity 93%

#### Extreme climate environments (products with suffix ‘H’ and ‘T’)

- Temperatures ranging from -25 to +70 °C/-13 to 158 °F
- Relative humidity levels up to 93% from -25 °C/-13 °F to +60 °C/140 °F
- Formation of ice
- Altitudes from 0 to 5,000 m/0 to 16,404 ft

*Note: Some products with the suffix ‘C’ also operate in an extended temperature range (from -25 °C to +60 °C/-13 °F to 140 °F). Please contact our Customer Care Center.*

(1) Each slot in a **BM●XBP●●00** rack is equipped as standard with a protective cover that should only be removed when inserting a module. If any covers are subsequently misplaced, replacements can be ordered under reference **BMXXEM010** (sold in lots of 5).



Protective gel BMXGEL0025

### Presentation (continued)

#### Specific characteristics for Safety modules

All Safety modules are coated and only exist with this surface treatment. There is no T, C, or H extension in the product references. Safety modules are compatible with:

- a temperature range from -25...+60 °C/-13...140 °F
- corrosive environments using common H components

**A protective gel is needed to cover all electrical connections on X80 products used in corrosive environments.**

This gel comes in a 25 g tube and can be ordered separately under the reference **BMXGEL0025**.

### X80 offer composition for severe environments

To order ruggedized modules and racks, see the reference tables from [page 9/3](#) to [page 9/9](#) :

- References of available ruggedized products include the suffix "H"
- References of available conformal coated products include the suffix "C".

The majority of operating and electrical characteristics of ruggedized modules are identical to those of their equivalent standard versions. However, some characteristics are subject to either derating or limitation. Please consult our website [www.se.com](http://www.se.com).

In this chapter, note that only X80 products are described.

- For M580 or M340 products, please refer to related catalog:



DIA6ED2151012EN



DIA6ED2110104EN

- For additional accessories, please refer to:
  - Standard accessories for racks, [page 2/5](#) and [page 2/9](#)
  - Standard accessories for power supplies, [page 2/3](#)
  - Standard accessories for I/O modules, [page 4/13](#)
  - Standard accessories for expert modules, [page 4/13](#)

# Modicon X80 module platform

Dedicated parts for severe environments  
X80 Racks and rack expansion module for severe environments

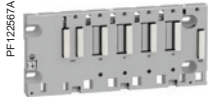

BMXXBP0400H

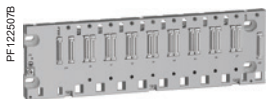

BMEXBP0800H



BMXXBE1000H

### X80 Racks and rack expansion module for severe environments

Description	Type of module to be inserted	No. of slots (1)	Power consumption (2)	Reference	Weight kg/lb
<b>Ruggedized X-bus racks</b>	BMXCPS power supply, BMXP34 or BMEP58 processor, BMEH58 processor, I/O modules, and application-specific (counter and communication) modules	4	1 W	<a href="#">BMXXBP0400H</a>	0.630/1.389
		6	1.5 W	<a href="#">BMXXBP0600H</a>	0.790/1.742
		8	2 W	<a href="#">BMXXBP0800H</a>	0.950/2.094
		12	0.74 W	<a href="#">BMXXBP1200H</a>	1.270/2.800
<b>Ruggedized Ethernet + X-bus racks</b>	BMXCPS power supply, BMEP58 processor, BMEH58 processor, I/O modules, and application-specific (counter and communication) modules	4	2.8 W	<a href="#">BMEXBP0400H</a>	0.715/1.576
		8	3.9 W	<a href="#">BMEXBP0800H</a>	1.070/2.359
		12	3.9 W	<a href="#">BMEXBP1200H</a>	1.387/3.058
<b>Ruggedized Ethernet + X-bus dual power supply racks</b>	BMEP58 processor, BMEH58 processor, BMXCPS400● redundant power supply, I/O modules, and application-specific (counter and communication) modules	6	3.9 W	<a href="#">BMEXBP0602H</a>	1.387/3.058
		10	3.9 W	<a href="#">BMEXBP1002H</a>	1.387/3.058

Description	Use	Reference	Weight kg/lb
<b>Ruggedized rack expansion module (3)</b>	Standard module to be installed in each rack (XBE slot) Used to daisy chain 2, 4, or 8 racks depending on the types of M340 or M580 processor	<a href="#">BMXXBE1000H</a>	0.178/0.392

(1) Number of slots taking the processor module, I/O modules, and application-specific modules (excluding power supply module).  
 (2) Power consumption of anti-condensation resistor(s).  
 (3) Module and cordsets do not operate properly at temperatures **lower than -25 °C/-13 °F**.

# Modicon X80 module platform

## Dedicated parts for severe environments

### X80 Power supplies for severe environments

#### X80 Power supplies for severe environments

Each **BM●XBP●●00H** rack must be equipped with a power supply. **BMEXBP●●02H** must be equipped with 1 or 2 redundant power supplies. These modules are inserted in the leftmost power supply slots of each rack (marked CPS).

The available power values given below in **bold italic** correspond to operation at  $-25\text{ }^{\circ}\text{C}/-13\text{ }^{\circ}\text{F}$  and  $+70\text{ }^{\circ}\text{C}/+158\text{ }^{\circ}\text{F}$  (see temperature derating curves on our website [www.se.com](http://www.se.com)).

The power required to supply each rack depends on the type and number of modules installed in the rack. It is therefore necessary to draw up a power consumption table for each rack in order to determine which is the most appropriate **BMXCPS●●●●H** power supply for your requirements (consult our website [www.se.com](http://www.se.com)).



BMXCPS3020H



BMXCPS3500H



BMXCPS4002H



BMXCPS4022H



BMXCPS3522H

#### X80 Power supplies for severe environments (1)

Line supply	Available power (2)			Total	Reference	Weight kg/lb
	3.3 V $\overline{\overline{\square}}$ (3)	24 V $\overline{\overline{\square}}$ rack (3)	24 V $\overline{\overline{\square}}$ sensors (4)			
24...48 V $\overline{\overline{\square}}$ isolated	15 W	32 W	–	32 W	BMXCPS3020H	0.340/ 0.750
	<b>11.3 W</b>	<b>23.4 W</b>		<b>23.4 W</b>		
100...240 V $\sim$	15 W	31.2 W	21.6 W	36 W	BMXCPS3500H	0.360/ 0.794
	<b>11.3 W</b>	<b>23.4 W</b>	<b>16.2 W</b>	<b>27 W</b>		
	18 W	40 W	–	40 W	BMXCPS4002H	0.360/ 0.794
	<b>18 W</b>	<b>40 W</b>		<b>40 W</b>		
24...48 V $\overline{\overline{\square}}$	18 W	40 W	–	40 W	BMXCPS4022H	0.810/ 1.786
	<b>18 W</b>	<b>40 W</b>		<b>40 W</b>		
125 V $\overline{\overline{\square}}$	18 W	40 W	–	40 W	BMXCPS3522H	0.610/ 1.345
	<b>18 W</b>	<b>40 W</b>		<b>40 W</b>		

(1) Includes a set of 2 removable caged connectors **BMXXTSCPS10**.

(2) The total power consumed on each voltage (3.3 V  $\overline{\overline{\square}}$  and 24 V  $\overline{\overline{\square}}$ ) must not exceed the total power of the module. See the power consumption table on our website [www.se.com](http://www.se.com).

(3) 3.3 V  $\overline{\overline{\square}}$  and 24 V  $\overline{\overline{\square}}$  rack voltages for powering Modicon M340 and M580 PLC modules.

(4) 24 V  $\overline{\overline{\square}}$  sensor voltage for powering the input sensors (voltage available via the 2-way removable connector on the front panel).

References						
X80 Discrete input modules for severe environments						
Type of current	Input voltage	Connection via (1)	IEC/EN 61131-2 conformity	No. of channels (common x channels per group)	Reference	Weight kg/lb
☰	24 V (positive logic)	20-way caged, screw clamp, or spring-type removable terminal block	Type 3	16 inputs (1 x 16)	<a href="#">BMXDDI1602H</a>	0.115/0.254
		One 40-way connector	Type 1	32 inputs (2 x 16)	<a href="#">BMXDDI3202KH</a>	0.110/0.243
		Two 40-way connectors	Non-type	64 inputs (4 x 16)	<a href="#">BMXDDI6402KH</a>	0.145/0.320
	24 V (positive/negative logic)	20-way caged, screw clamp, or spring-type removable terminal block	Non-type	16 inputs (1 x 16)	<a href="#">BMXDAI1602H</a>	0.115/0.254
	12/24 V (positive/negative logic)	40-way caged or spring-type removable terminal block	Type 3	32 inputs (2 x 16)	<a href="#">BMXDDI3232H</a>	0.138/0.30
	48 V	20-way caged, screw clamp, or spring-type removable terminal block	Type 1	16 inputs (1 x 16)	<a href="#">BMXDDI1603H</a>	0.115/0.254
40-way caged or spring-type removable terminal block		Type 3	32 inputs (2 x 16)	<a href="#">BMXDDI3203H</a>	0.138/0.304	
~	24 V	20-way caged, screw clamp, or spring-type removable terminal block	Type 1	16 inputs (1 x 16)	<a href="#">BMXDAI1602H</a>	0.115/0.254
		48 V	20-way caged, screw clamp, or spring-type removable terminal block	Type 3	16 inputs (1 x 16)	<a href="#">BMXDAI1603H</a>
	100...120 V	20-way caged, screw clamp, or spring-type removable terminal block	Type 3	16 inputs (1 x 16)	<a href="#">BMXDAI1604H</a>	0.115/0.254
		40-way caged or spring-type removable terminal block	Type 1	16 isolated inputs	<a href="#">BMXDAI1614H</a>	0.150/0.331
	200...240 V	40-way caged or spring-type removable terminal block	Type 1	16 isolated inputs	<a href="#">BMXDAI1615H</a>	0.156/0.344



BMXDDI1602H  
BMXDAI0802H



BMXDAI16102H



BMXDDO1602H BMXDDO6402KH



BMXDAO1605H BMXDAO1615H



BMXDRA0805H BMXDRC0805H

X80 Discrete output modules for severe environments						
Type of current	Output voltage	Connection via (1)	IEC/EN 61131-2 conformity	No. of channels (common x channels per group)	Reference	Weight kg/lb
☰ transistor	24 V (positive logic)	20-way caged, screw clamp, or spring-type removable terminal block	Yes	16 outputs (1 x 16)	<a href="#">BMXDDO1602H</a>	0.120/0.265
		20-way caged, screw clamp, or spring-type removable terminal block	Yes	16 outputs (1 x 16)	<a href="#">BMXDDO1612H</a>	0.120/0.265
	24 V (positive logic)	One 40-way connector	Yes	32 outputs (2 x 16)	<a href="#">BMXDDO3202KC</a>	0.110/0.243
		Two 40-way connectors	Yes	64 outputs (4 x 16)	<a href="#">BMXDDO6402KC</a>	0.150/0.331
~ triac	100...240 V	20-way caged, screw clamp, or spring-type removable terminal block	Yes	16 outputs (4 x 4)	<a href="#">BMXDAO1605H</a>	0.140/0.309
	24...240 V	40-way caged or spring-type removable terminal block	Yes	16 isolated outputs	<a href="#">BMXDAO1615H</a>	0.250/0.551
☰ / ~ relay	24 V ☰ 24...240 V ~	20-way caged, screw clamp, or spring-type removable terminal block	Yes	8 normally open isolated relay outputs	<a href="#">BMXDRA0805H</a>	0.145/0.320
		20-way caged, screw clamp, or spring-type removable terminal block	Yes	8 normally open isolated relay outputs	<a href="#">BMXDRA0815H</a>	0.210/0.463
	24 V ☰ 240 V ~	20-way caged, screw clamp, or spring-type removable terminal block	Yes	16 normally open relay outputs (2 x 8)	<a href="#">BMXDRA1605H</a>	0.150/0.331
		40-way caged or spring-type removable terminal block	Yes	8 normally open and normally closed isolated relay outputs	<a href="#">BMXDRC0805H</a>	0.189/0.417

(1) By connector, module supplied with cover(s)



PF106132  
BMXDDM1602●H



PF106148  
BMXART0414H



X80\_61938\_CPSC118010H  
BMEAH10812H



PF106171  
BMXAM●0●●●0H



X80\_61938\_CPSC118011B  
BMEAH0412C

## References

### X80 Discrete mixed I/O modules for severe environments

Type	Voltage		Connection via (2)	IEC/EN 61131-2 conformity		No. of channels (common x channels per group)		Reference	Weight kg/lb
	Inputs	Outputs		Inputs	Outputs	Inputs	Outputs		
transistor	24 V $\overline{\text{---}}$	24 V $\overline{\text{---}}$	20-way caged, screw clamp, or spring-type removable terminal block	Type 3	Yes	8 (1 x 8)	8 (1 x 8)	BMXDDM16022H	0.115/0.254
relay	24 V $\overline{\text{---}}$	24...240 V $\sim$		Type 3	Yes	8 (1 x 8)	8 (1 x 8)	BMXDDM16025H	0.135/0.298

### X80 Analog input modules for severe environments

Type of inputs	Input signal range	Resolution	Connection	No. of channels	Reference	Weight kg/lb
Isolated high-level inputs	$\pm 10$ V, 0...10 V, 0...5 V, 1...5 V, $\pm 5$ V, 0...20 mA, 4...20 mA, $\pm 20$ mA	16 bits	20-way caged, screw clamp, or spring-type removable terminal block	4 inputs	BMXAMI0410H	0.143/0.315
			28-way caged, screw clamp, or spring-type removable terminal block	8 inputs	BMXAMI0810H	0.175/0.386
Isolated low-level inputs	Temperature probe, thermocouple, $\pm 40$ mV, $\pm 80$ mV, $\pm 160$ mV, $\pm 320$ mV, $\pm 640$ mV, $\pm 1.28$ V	15 bits + sign	40-way connector	4 inputs	BMXART0414H	0.135/0.298
				8 inputs	BMXART0814H	0.165/0.364

### X80 HART analog input module for severe environments

Type of inputs	Input signal range	Resolution	Connection	No. of channels	Reference	Weight kg/lb
Isolated high-level inputs	4...20 mA	15 bits + sign	20-way caged, screw clamp, or spring-type removable terminal block	8 inputs	BMEAH10812H	0.233/0.514

### X80 Analog output modules for severe environments

Type of outputs	Output signal range	Resolution	Connection	No. of channels	Reference	Weight kg/lb
Isolated high-level outputs	$\pm 10$ V, 0...20 mA, 4...20 mA	16 bits	20-way caged, screw clamp, or spring-type removable terminal block	2 outputs	BMXAMO0210H	0.144/0.317
				4 outputs	BMXAMO0410H	0.175/0.386
Non-isolated high-level outputs	0...20 mA, 4...20 mA	15 bits + sign	20-way caged, screw clamp, or spring-type removable terminal block	8 outputs	BMXAMO0802H	0.150/0.331

### X80 HART analog output module for severe environments

Type of outputs	Output signal range	Resolution	Connection	No. of channels	Reference	Weight kg/lb
Isolated high-level outputs	4...20 mA	15 bits + sign	20-way caged, screw clamp, or spring-type removable terminal block	4 outputs	BMEAH0412C	0.223/0.492

### X80 Mixed analog I/O module for severe environments

Type of outputs	Signal range		Resolution	Connection	No. of channels		Reference	Weight kg/lb
	Inputs	Outputs			Inputs	Outputs		
Mixed I/O, non-isolated	$\pm 10$ V, 0...10 V, 0...5 V, 1...5 V, 0...20 mA, 4...20 mA	$\pm 10$ V, 0...20 mA, 4...20 mA	14 or 12 bits depending on the range	20-way caged, screw clamp, or spring-type removable terminal block	4 inputs	2 outputs	BMXAMM0600H	0.155/0.342

# Modicon X80 module platform

## Dedicated parts for severe environments

### X80 Expert modules for severe environments



BMXEHC0200H



BMXEHC0800H



BMXERT1604H



BMXEAE0300H

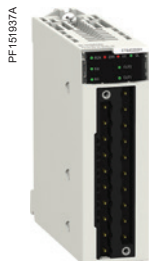

BMXETM0200H

### References

#### X80 Counter modules for severe environments

Description	Characteristics	Connection via	No. of channels	Reference	Weight kg/lb
<b>Counter modules</b> for 24 V $\overline{\text{DC}}$ 2- and 3-wire sensors and 10/30 V $\overline{\text{DC}}$ incremental encoders with push-pull outputs	60 kHz counting	2 x 16-way connector and 1 10-way connector	2	<a href="#">BMXEHC0200H</a>	0.112 0.247
	10 kHz counting	20-way caged, screw clamp, or spring-type removable terminal block	8	<a href="#">BMXEHC0800H</a>	0.113 0.249

#### X80 Time-stamping module for severe environments

Description	Characteristics	Connection via	No. of channels	Reference	Weight kg/lb
<b>Multifunction time-stamping input module</b>	Time- and date-stamping at 1 ms 1.6 < resolution < 3.3 ms store up to local 4000 events (255 groups, each group 16 channel) (1) 16 discrete inputs on module	28-way caged or spring-type removable terminal block	16	<a href="#">BMXERT1604H</a>	0.119/ 0.262

#### X80 SSI encoder interface module for severe environments

Description	Characteristics	Connection via	No. of channels	Reference	Weight kg/lb
<b>SSI encoder interface module</b>	8- to 31-bit data width 4 baud rates: 100 kHz, 200 kHz, 500 kHz, 1 MHz	28-way caged or spring-type removable terminal block	3	<a href="#">BMXEAE0300H</a>	0.138/ 0.304

#### X80 Frequency input module for severe environments

Description	Characteristics	Connection via	No. of channels	Reference	Weight kg/lb
<b>Speed and frequency control module for turbomachinery application</b>	Input frequency: 0...500Hz, reflex digital output	28-way caged or spring-type removable terminal block	2	<a href="#">BMXETM0200H</a>	0.124/ 0.273

#### Removable terminal blocks for severe environments

Description	Type	Reference	Weight kg/lb
40-way removable terminal block	Caged	<a href="#">BMXFTB4000H</a>	0.166/ 0.366
	Spring	<a href="#">BMXFTB4020H</a>	0.098/ 0.216

(1) This maximum value is not an absolute value. It depends on the overall system dynamics (total number of scanned items and number of events generated by the system).

(2) The shielding on the cordsets carrying the counter signals must always be connected to the **BMXXSP●●00** shielding connection kit mounted under the rack holding the **BMXEHC0200H** module (see [page 2/3](#)).



# Modicon X80 module platform

Dedicated parts for severe environments

X80 I/O expansion modules, communication modules, and gateway for severe environments



BMECRA31210C



BMXCRA31210C



PMEPM0100H



BMXNRP020C



BMECXM0100H



BMENOS0300C



TCSEGPA23F14FK

## References

### X80 Remote I/O drop adapters for severe environments

Description	SERVICE port	Reference	Weight kg/lb
X80 Remote I/O drop adapter	1	<a href="#">BMECRA31210C</a>	–
X80 Remote I/O drop adapter	1	<a href="#">BMXCRA31210C</a>	–

### X80 Serial link module for severe environments

Description	Protocol	Physical layer	Reference	Weight kg/lb
<b>Serial link module (2 channels)</b>	Modbus client/server RTU/ASCII, Character mode, GSM/GPRS modem	1 non-isolated RS 232 channel (SL0) 2 isolated RS 485 channels (SL0 and SL1)	<a href="#">BMXNOM0200H</a>	0.230/ 0.507

### X80 CANopen client module for severe environments

Description	Protocols	Physical layer	Reference	Weight kg/lb
<b>CANopen communication module</b>	CiA 301 V4.2 standard (client or server), Ethernet/IP	ISO 11898 (9-way SUB-D connector)	<a href="#">BMECXM0100H</a>	0.200/ 0.441

### X80 PROFIBUS DP module for severe environments

Description	Protocols	Physical layer	Reference	Weight kg/lb
<b>X80 Profibus DP Master module</b>	Implicit exchange of process data	EIA-485 (optical, MBP)	<a href="#">PMEPM0100H</a>	0.270/ 0.595

### X80 PROFIBUS DP network gateway for severe environments

Description	Protocols	Physical layer	Reference	Weight kg/lb
<b>Profibus Remote Master (PRM) module</b>	Modbus TCP	1 Ethernet switch, 2 ports 10BASE-T/ 100BASE-TX	<a href="#">TCSEGPA23F14FK</a>	–
	Profibus DP V1 and Profibus PA (via gateway)	1 isolated RS 485 Profibus DP port		

### Modbus Plus Proxy module for severe environments

Description	Supplied with	Reference	Weight kg/lb
<b>Modbus Plus Proxy module</b>	2 front-mounted power supply connectors (2 positions)	<a href="#">TCSEGDB23F24FK</a>	–

### X80 Fiber converter modules for severe environments (1) (2)

Description	Optical fiber	Reference	Weight kg/lb
<b>Modules for fiber optic communications over long distances</b>	Multimode	<a href="#">BMXNRP0200C</a>	–
	Single-mode	<a href="#">BMXNRP0201C</a>	–

### X80 Ethernet switch module for severe environments

Description	SERVICE port	Device network port(Ethernet)	Reference	Weight kg/lb
<b>Ethernet switch module</b>	1	2	<a href="#">BMENOS0300C</a>	–

### Connection accessories

Designation	Description	RS 232 interface	Reference	Weight kg/lb
<b>Cordset for DCE terminal (modem, etc.)</b>	Equipped with 1 x RJ45 connector and 1 x 9-way male SUB-D connector Length 3 m/9.84 ft	Simplified 4-wire (RX, TX, RTS, and CTS)	<a href="#">TCSMCN3M4M3S2</a>	0.150/ 0.331
		Full 8-wire (except RI signal)	<a href="#">TCSXCN3M4F3S4</a>	0.165/ 0.364

(1) Requires Unity Pro Extra Large software ≥ V7.0; see our website [www.se.com](http://www.se.com).

(2) Supports operation at -25 to 60°C / -13 to 140°F.



---

## Technical appendices

- Standards, certifications, and environmental conditions ..... [page 10/2](#)
- Per region ..... [page 10/2](#)
- Per application ..... [page 10/2](#)
- Functional safety ..... [page 10/3](#)
- Environmental characteristics ..... [page 10/4](#)
- Protective treatment of the Modicon X80 module platform ..... [page 10/4](#)
- Installation restrictions and recommendations ..... [page 10/4](#)
- Environment tests ..... [page 10/5](#)
- Certifications and EC regulations for automation products ..... [page 10/10](#)

## Dedicated service offers for your installed base

- Maintenance and support services ..... [page 10/12](#)
- Consultancy services ..... [page 10/13](#)
- Modernization solutions ..... [page 10/13](#)
- Customization services ..... [page 10/13](#)

## Index

- Product reference index ..... [page 10/14](#)



### Standards and certifications

#### Per region

The Modicon X80 modules and X80 Safety modules have been developed to comply with the principal national and international standards concerning electronic equipment for industrial automation systems. Up-to-date information on which certifications have been obtained is available on our website: consult commercial references directly.

- Compliance with European Directives for CE marking:
  - WEEE: 2012/19/EU
  - Low voltage: 2014/35/EU
  - Electromagnetic compatibility: 2014/30/EU
  - Machinery: 2006/42/EC (check EU DoC on our website [www.se.com](http://www.se.com))
  - ATEX: 2014/34/EU (check EU DoC on our website [www.se.com](http://www.se.com))
- Requirements specific to programmable controllers (functional characteristics, immunity, resistance, safety, etc.):
  - IEC/EN 61131-2
  - IEC/EN/UL/CSA 61010-2-201
- Country specific passport:
  - RCM
  - EAC
  - UKCA

For other country certifications, please refer to the technical appendix [page 10/10](#).

X80 modules are considered as open equipment and are designed for use in industrial environments, in pollution degree 2, overvoltage category II (IEC 60664-1), and in low-voltage installations, where the main power branch is protected on both wires by devices such as fuses or circuit breakers limiting the current to 15A for North America and 16A for the rest of the world.

#### Per application

##### Power generation

- IEC/EN 61000-6-5 for interfaces type 1 and 2
- IEC/EN 61850-3 for locations G

##### Merchant navy

Merchant navy requirements of the major international organizations are unified in IACS (International Association of Classification Societies) IACS E10 rules: BV, DNV, ABS, LR, RINA (refer to [page 10/10](#)).

##### Railway

- EN 50155/IEC 60571: Railway applications - Rolling stock - Electronic equipment
- EN 50121-3-2/IEC 62236-3-2: Railway applications - Electromagnetic compatibility - Part 3-2: Rolling stock - Apparatus
- EN 50121-4/IEC 62236-4: Railway applications - Electromagnetic compatibility - Part 4: Emission and immunity of the signalling and telecommunications apparatus
- EN 50121-5/IEC 62236-5: Railway applications - Electromagnetic compatibility - Part 5: Emission and immunity of fixed power supply installations and apparatus
- EN 50124-1/IEC 62947-1: Railway - Insulation coordination - Part 1: Basic requirements - Clearances and creepage distances for all electrical and electronic equipment
- EN 50125-1/IEC 62498-1: Railway - Environmental conditions for equipment - Part 1: Rolling stock and on-board equipment
- EN 50125-3/IEC 62498-3: Railway - Environmental conditions for equipment - Part 3: Equipment for signaling and telecommunications

##### Hazardous areas

- For USA and Canada: Hazardous location class I, division 2, groups A,B,C, and D
- For European Union: ATEX for atmosphere Zone 2 (gas) and Zone 22 (dust)
- For United Kingdom: UKEX for atmosphere Zone 2 (gas) and Zone 22 (dust)
- For other countries: IECEx for atmosphere Zone 2 (gas) and/or Zone 22 (dust)



### Standards and certifications (continued)

#### Functional safety

All Safety modules are certified by TÜV Rheinland.

The certificate reviews the following standards:

##### ■ Generic safety

- IEC/EN 61508: Functional safety of electrical/electronic/programmable electronic safety-related systems
  - IEC/EN 61508-1 - Part 1: General requirements
  - IEC/EN 61508-2 - Part 2: Requirements for electrical/electronic/programmable electronic safety-related systems
  - IEC/EN 61508-3 - Part 3: Software requirements

##### ■ Safety for Process

- IEC/EN 61511: Functional safety - Safety instrumented systems for the process industry sector
  - IEC/EN 61511-1 - Part 1: Framework, definitions, system, hardware and software requirements
  - IEC/EN 61511-2 - Part 2: Guidelines for the application of IEC 61511-1
  - IEC/EN 61511-3 - Part 3: Guidance for the determination of the required safety integrity levels

##### ■ Safety for Machine

- IEC/EN 62061: Safety of machinery - Functional safety of safety-related electrical, electronic and programmable electronic control systems
- ISO/EN 13849-1: Safety of machinery - Safety-related parts of control systems - Part 1: General principles for design
- ISO/EN 13849-2: Safety-related parts of control systems - Part 2: Validation

##### ■ Safety for Railway

- EN 50126/IEC 62278: Railway Applications - The Specification and demonstration of reliability, availability, maintainability and safety (RAMS)
- EN 50128/IEC 62279: Railway Applications - Communication, signaling and processing systems. Software for railway control and protection systems
- EN 50129/IEC 62425: Railway applications -Communication, signaling and processing systems - Safety-related electronic systems for signaling

#### Fire & Gas

- EN 54.2 Fire detection and fire alarms systems – Part 2: Control and indicating equipment
- EN 50156-1 Electrical equipment for furnaces and ancillary equipment - Part 1: Requirements for application design and installation
- EN 50130-4 Immunity requirements components of fire, intruder, holdup, CCTV, access control and social alarms systems
- EN 298 Automatic burner control systems for burners and appliances burning gaseous or liquid fuels
- NFPA 85 Boiler and Combustion Systems Hazards Code
- NFPA 86 Standard for Ovens and Furnaces
- NFPA 72 National Fire Alarm and Signaling Code

Environmental characteristics							
Service conditions and recommendations relating to the environment							
			Modicon X80 modules	Modicon X80 Safety modules	Modicon X80 modules for severe environments		
Temperature	Operation	°C/°F	0...+60/32...140	-25...+60/-13...+140	-25...+70/-13...+158		
	Storage	°C/°F	-40...+85/-40...+185	-40...+85/-40...+185	-40...+85/-40...+185		
Relative humidity (without condensation)	Cyclical humidity	%	+5 ... +95 up to 55 °C/131 °F	+5...+95 up to 55 °C/131 °F	+5 ... +95 up to 55 °C/131 °F		
	Continuous humidity	%	+5 ... +93 up to 55 °C/131 °F	+5...+93 up to 60 °C/140 °F	+5 ... +93 up to 60 °C/140 °F		
Altitude	Operation	m/ft	0...2,000/0...6,562 (full specification: temperature and isolation) 2,000...5,000/6,562...16,404 (temperature derating: approx. 1 °C/400 m (33.8 °F/1,312 ft), isolation 150 V/1,000 m/3,281 ft) For accurate temperature derating calculation, refer to IEC 61131-2 Ed.4.0 Annex A				
Modicon X80 power supplies							
Supply voltage			BMXCPS2010	BMXCPS3020 BMXCPS3020H	BMXCPS3540T BMXCPS3522 BMXCPS3522S	BMXCPS2000	BMXCPS3500 BMXCPS3500H BMXCPS4002 BMXCPS4002S BMXCPS4002H BMXCPS4022S
	Nominal voltage	V	24 ---	24...48 ---	125 ---	100...240 ~	100...240 ~
	Limit voltages	V	18...31.2 ---	18...62.4 ---	100...150 ---	85...264 ~	85...264 ~
	Nominal frequencies	Hz	–	–	–	50/60	50/60
	Limit frequencies	Hz	–	–	–	47/63	47/63

### Protective treatment of the Modicon X80 module platform

The Modicon X80 modules and X80 Safety modules meet the requirements of “TC” treatment (treatment for all climates).

For installations in industrial production workshops or environments corresponding to “TH” treatment (treatment for hot and humid environments), Modicon X80 modules must be embedded in enclosures with minimum IP54 protection.

The Modicon X80 modules and X80 Safety modules offer **protection to IP20 level** and **protection against access to terminals** (enclosed equipment) (1). They can therefore be installed without an enclosure in reserved-access areas that do not exceed **pollution level 2** (control room with no dust-producing machine or activity). Pollution level 2 does not take account of more severe environmental conditions: air pollution by dust, smoke, corrosive or radioactive particles, vapors or salts, molds, insects, etc.

### Installation restrictions and recommendations

Please note that in order to fulfill the international certification conditions:

- Devices must be installed, wired, and maintained in accordance with the instructions provided in the manual “Grounding and Electromagnetic Compatibility of PLC Systems”;
- Installation restrictions are provided in “Modicon M580, M340, X80 Platforms, Standards and Certifications” and “Modicon M580 Safety, Standards and Certifications” manuals.

Download manuals for further details:

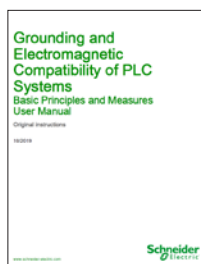

33002439KO1000



EIO0000002726



EIO0000002750

(1) In cases where a slot is not occupied by a module, a BMXXEM010 protective cover must be installed (see Modicon X80 module platform catalog).

(CE): Tests required by European directives (CE) and based on IEC/EN 61131-2 standards.

### Environment tests

The table below (pages 10/5 to 10/9) provides test values for Industry; for Power generation, Merchant navy, and Railway application related tests, please refer to “Modicon M580, M340, and X80 platforms, Standards and Certifications - Installation & User guide” (see page 10/4).

Name of test	Standards	Levels
<b>Immunity to LF interference (CE) (1)</b>		
Voltage and frequency variations	IEC/EN 61131-2; IEC/EN 61000-6-2; IEC 61000-4-11	0.85...1.10 Un - 0.94...1.04 Fn; 4 steps t = 30 min
Direct voltage variations	IEC/EN 61131-2; IEC 61000-4-29	0.85...1.2 Un + ripple: 5% peak; 2 steps t = 30 min
Third harmonic	IEC/EN 61131-2	H3 (10% Un), 0°/180°; 2 steps t = 5 min
Voltage interruptions	IEC/EN 61131-2; IEC/EN 61000-6-2; IEC 61000-4-11; IEC 61000-4-29 For functional safety (DS criteria): IEC 61000-6-7; IEC 61326-3-1	Power supply immunity: <ul style="list-style-type: none"> <li>■ 1 ms for --- PS1/10 ms for ~ PS2 (20 ms DS criteria), 85% Un</li> <li>■ Check operating mode for longer interruptions up to 5s, 85% Un</li> </ul>
	IEC/EN 61131-2; IEC/EN 61000-6-2; IEC 61000-4-11	For ~ PS2: <ul style="list-style-type: none"> <li>■ 20% Un, t0: ½ period</li> <li>■ 40% Un, cycle 10/12</li> <li>■ 70% Un, cycle: 25/30</li> <li>■ 0% Un, cycle 250/300</li> </ul>
Voltage shut-down and start-up	IEC/EN 61131-2	<ul style="list-style-type: none"> <li>■ Un...0...Un; t = Un/60 s</li> <li>■ Umin...0...Umin; t = Umin/5 s</li> <li>■ Umin...0.9 Udl...Umin; t = Umin/60 s</li> </ul>
Magnetic field	IEC/EN 61131-2; IEC 61000-4-8 For functional safety (DS criteria): IEC 61000-6-7; IEC 61326-3-1 IEC 61000-4-10	Power frequency: 50/60 Hz, 100 A/m continuous ...1000 A/m; t = 3 s; 3 axes
Conducted common mode disturbances range 0 Hz ...150 kHz	IEC 61000-4-16 For functional safety (DS criteria): IEC 61000-6-7; IEC 61326-3-1	Oscillatory: 100 kHz...1 MHz, 100 A/m; t = 9 s; 3 axes  For remote systems: <ul style="list-style-type: none"> <li>■ 50/60 Hz and ---, 300 V, t = 1 s</li> <li>■ 50/60 Hz and ---, 30 V, t = 1 min</li> <li>■ 5 Hz...150 kHz, sweep 3 V...30 V</li> <li>■ For AC: 10 V</li> <li>■ For DC: 10 V cont. or 100 V, t = 1 s</li> </ul>

Where:

- PS1 applies to PLC supplied by battery, PS2 applies to PLC energized from ~ or --- supplies
- Un: nominal voltage, Fn: nominal frequency, Udl: detection level when powered

(1) Devices must be installed, wired, and maintained in accordance with the instructions provided in the manual “Grounding and Electromagnetic Compatibility of PLC Systems” (see page 10/4).

(2) These tests are performed without an enclosure, with devices fixed on a metal grid and wired as per the recommendations in the manual “Grounding and Electromagnetic Compatibility of PLC systems” (see page 10/4).

(CE): Tests required by European CE directives and based on IEC/EN 61131-2.

Environment tests (continued)		
Name of test	Standards	Levels
<b>Immunity to HF interference (CE) (1)</b>		
Electrostatic discharges	IEC/EN 61131-2; IEC/EN 61000-6-2; IEC 61000-4-2 For functional safety (DS criteria): IEC 61000-6-7; IEC 61326-3-1	6 kV contact; 8 kV air; 6 kV indirect contact
Radiated radio frequency electromagnetic field	IEC/EN 61131-2; IEC/EN 61000-6-2; IEC 61000-4-3 For functional safety (DS criteria): IEC 61000-6-7; IEC 61326-3-1	80MHz...1GHz: 10/15 V/m (20 V/m DS criteria); 3 V/m, 1.4 GHz...2 GHz: 3V/m (10 V/m DS criteria) 2 GHz...6 GHz: 3V/m Sinus amplitude modulated 80%, 1 kHz + internal clock frequencies
Electrical fast transient bursts	IEC/EN 61131-2; IEC/EN 61000-6-2; IEC 61000-4-4 For functional safety (DS criteria): IEC 61000-6-7; IEC 61326-3-1	For ~ or --- main supplies: ■ 2 kV in common mode/2 kV in wire mode (4 kV DS criteria with external protection) For ~ or --- auxiliary supplies, ~ unshielded I/O: ■ 2 kV in common mode For analog, --- unshielded I/O, communication and shielded lines: ■ 1 kV in common mode (3 kV DS criteria)
Surge	IEC/EN 61131-2; IEC/EN 61000-6-2; IEC 61000-4-5 For functional safety (DS criteria): IEC 61000-6-7; IEC 61326-3-1	For ~/--- main and auxiliary supplies, ~ unshielded I/O: ■ 2 kV in common mode/1 kV in differential mode (4 kV DS criteria with external protection) For analog, --- unshielded I/O: ■ 2 kV in common mode/2 kV in differential mode For communication and shielded lines: ■ 1 kV in common mode (3 kV DS criteria)
Conducted disturbances induced by radiated electromagnetic fields	IEC/EN 61131-2; IEC/EN 61000-6-2; IEC 61000-4-6 For functional safety (DS criteria): IEC 61000-6-7; IEC 61326-3-1	10 V; 0.15 MHz...80 MHz (20 V DS criteria) Sinus amplitude 80%, 1 kHz + spot frequencies
Damped oscillatory wave	IEC/EN 61131-2; IEC 61000-4-18	For ~/--- main supplies and ~ auxiliary supplies, ~ unshielded I/O: ■ 2.5 kV in common mode/1 kV in differential mode For --- auxiliary supplies, analog, --- unshielded I/O: ■ 1 kV in common mode/0.5 kV in differential mode For communication and shielded lines: ■ 0.5 kV in common mode

(1) Devices must be installed, wired, and maintained in accordance with the instructions provided in the manual "Grounding and Electromagnetic Compatibility of PLC Systems" (see page 10/4).

(2) These tests are performed without an enclosure, with devices fixed on a metal grid and wired as per the recommendations in the manual "Grounding and Electromagnetic Compatibility of PLC systems" (see page 10/4).

(CE): Tests required by European CE directives and based on IEC/EN 61131-2.



Environment tests (continued)		
Name of test	Standards	Levels
<b>Electromagnetic emissions (CE) (1)</b>		
Conducted emissions	IEC/EN 61131-2; IEC/EN 61000-6-4; CISPR 11 & 22, Class A, Group 1	150 kHz ... 500 kHz: quasi-peak 79 dB (µV/m); average 66 dB (µV/m) 500 kHz ... 30 MHz: quasi-peak 73 dB (µV/m); average 60 dB (µV/m)
Radiated emissions	IEC/EN 61131-2; IEC/EN 61000-6-4; CISPR 11 & 22, Class A, Group 1	30 MHz ... 230 MHz: quasi-peak 40 dB (µV/m) (at 10 m/33 ft) 230 MHz ... 1 GHz: quasi-peak 47 dB (µV/m) (at 10 m/33 ft) 1 GHz ... 3 GHz: quasi-peak 76 dB (µV/m) (at 3 m/9.84 ft) 3 GHz ... 6 GHz: quasi-peak 80 dB (µV/m) (at 3 m/9.84 ft)
Name of test	Standards	Levels
<b>Immunity to climatic variations (1) (power on)</b>		
Dry heat	IEC 60068-2-2 (Bb & Bd)	60 °C/140 °F, t = 16 hrs [for ruggedized range: 70 °C/158 °F, t = 16 hrs] (2)
Cold	IEC 60068-2-1 (Ab & Ad)	0 °C ... -25 °C/32 °F ... -13 °F, t = 16 hrs + power on at 0 °C/ 32 °F [for ruggedized range: power on at -25 °C/-13 °F] (2)
Damp heat, steady state (continuous humidity)	IEC 60068-2-78 (Cab)	55 °C/131 °F, 93% relative humidity, t = 96 hrs [for ruggedized range: 60 °C/140 °F] (2)
Damp heat, cyclic (cyclical humidity)	IEC 60068-2-30 (Db)	55 °C ... 25 °C/131 °F ... 77 °F, 93 ... 95% relative humidity, 2 cycles t = 12 hrs + 12 hrs
Change of temperature	IEC 60068-2-14 (Nb)	0 °C ... 60 °C/32 °F ... 140 °F, 5 cycles t = 6 hrs + 6 hrs [for ruggedized range: -25 °C ... 70 °C/-13 °F ... 158 °F] (2)
Name of test	Standards	Levels
<b>Withstand to climatic variations (1) (power off)</b>		
Dry heat	IEC/EN 61131-2; IEC 60068-2-2 (Bb & Bd)	85 °C/185 °F, t = 96 hrs
Cold	IEC/EN 61131-2; IEC 60068-2-1 (Ab & Ad)	-40 °C/-40 °F, t = 96 hrs
Damp heat, cyclic (cyclical humidity)	IEC/EN 61131-2; IEC 60068-2-30 (Db)	55 °C ... 25 °C/77 °F ... 131 °F, 93 ... 95% relative humidity, 2 cycles t = 12 hrs + 12 hrs
Change of temperature (thermal shocks)	IEC/EN 61131-2; IEC 60068-2-14 (Na)	-40 °C ... 85 °C/-40 °F ... 185 °F, 5 cycles t = 3 hrs + 3 hrs

(1) Devices must be installed, wired, and maintained in accordance with the instructions provided in the manual "Grounding and Electromagnetic Compatibility of PLC Systems" (see page 10/4).

(2) Refer also to the section "Treatment for severe environments".

(CE): Tests required by European CE directives and based on IEC/EN 61131-2 standards.

Environment tests (continued)		
Name of test	Standards	Levels
<b>Immunity to mechanical constraints (1) (power on)</b>		
Sinusoidal vibrations	IEC/EN 61131-2; IEC 60068-2-6 (Fc)	Basic IEC/EN 61131-2: 5 Hz ... 150 Hz, $\pm 3.5$ mm/0.14 in. amplitude (5 Hz ... 8.4 Hz), 1 g (8.4 Hz ... 150 Hz) Specific profile: 5 Hz ... 150 Hz, $\pm 10.4$ mm/0.41 in. amplitude (5 Hz ... 8.4 Hz), 3 g (8.4 Hz ... 150 Hz) For basic and specific: endurance: 10 sweep cycles for each axis
	IEC 60870-2-2; IEC 60068-2-6 (Class Cm)	2 Hz ... 500 Hz, 7 mm/0.28 in. amplitude (2 Hz ... 9 Hz), 2 g (9 Hz ... 200 Hz), 1.5 g (200 Hz ... 500 Hz) endurance: 10 sweep cycles for each axis
	IEC 60068-2-6	Seismic analysis: 3 Hz ... 35 Hz, 22.5 mm/0.89 in. amplitude (3 Hz ... 8.1 Hz), 6 g (8.1 Hz ... 35 Hz)
Shock	IEC/EN 61131-2; IEC 60068-2-27 (Ea)	30 g, 11 ms; 3 shocks/direction/axis (2) For M580 Safety: 15 g, 11 ms; 3 shocks/direction/axis 25 g, 6 ms; 100 bumps/direction/axis (bumps) (3)
Free fall during operation	IEC/EN 61131-2; IEC 60068-2-32 (Ed Method 1)	1 m/3.28 ft, 2 falls
<b>Name of test</b>		
<b>Standards</b>		
<b>Levels</b>		
<b>Withstand to mechanical constraints (power off)</b>		
Random free fall with packaging	IEC/EN 61131-2; IEC 60068-2-32 (Method 1)	1 m/3.28 ft, 5 falls
Flat free fall	IEC/EN 61131-2; IEC 60068-2-32 (Ed Method 1)	10 cm/0.33 ft, 2 falls
Controlled free fall	IEC/EN 61131-2; IEC 60068-2-31 (Ec)	30° or 10 cm/0.33 ft, 2 falls
Plugging/Unplugging	IEC/EN 61131-2	For modules and connectors: Operations: 50 for permanent connections, 500 for non-permanent connections

(1) Devices must be installed, wired, and maintained in accordance with the instructions provided in the manual "Grounding and Electromagnetic Compatibility of PLC Systems" (see page 10/4).

(2) When using fast actuators (response time  $\leq 5$  ms) driven by relay outputs: 15 g, 11 ms; 3 shocks/direction/axis.

(3) When using fast actuators (response time  $\leq 15$  ms) driven by relay outputs: 15 g, 6 ms; 100 bumps/direction/axis.

(4) Refer also to the section "Treatment for severe environments".

(Cc): Tests required by European Cc directives and based on IEC/EN 61131-2 standards.

Environment tests (continued)		
Name of test	Standards	Levels
<b>Equipment and personnel safety (1) (CE)</b>		
Dielectric strength and insulation resistance	IEC/EN 61131-2; IEC 61010-2-201; UL; CSA	Dielectric: $2 U_n + 1000 \text{ V}$ ; $t = 1 \text{ min}$ Insulation: $U_n \leq 50 \text{ V}$ : $10 \text{ M}\Omega$ , $50 \text{ V} \leq U_n \leq 250 \text{ V}$ : $100 \text{ M}\Omega$
Ground continuity	IEC/EN 61131-2; IEC 61010-2-201; UL; CSA	$30 \text{ A}$ , $R \leq 0,1 \Omega$ ; $t = 2 \text{ min}$
Leakage current	IEC/EN 61131-2; IEC 61010-2-201; UL; CSA	$\leq 0,5 \text{ mA}$ in normal condition $\leq 3,5 \text{ mA}$ in single fault condition
Protection offered by enclosures	IEC/EN 61131-2; IEC61010-2-201	IP20 and protection against standardized pins
Impact withstand	IEC/EN 61131-2; IEC 61010-2-201; UL; CSA	Sphere of $500 \text{ g}$ , fall from $1.3 \text{ m}/4.27 \text{ ft}$ (energy $6.8 \text{ J}$ minimum)
Overload	IEC/EN 61131-2; IEC 61010-2-201; UL; CSA	$50 \text{ cycles}$ , $U_n$ , $1,5 I_n$ ; $t = 1 \text{ s ON} + 9 \text{ s OFF}$
Endurance	IEC/EN 61131-2; IEC 61010-2-201; UL; CSA	$I_n$ , $U_n$ ; $6,000 \text{ cycles}$ : $t = 1 \text{ s ON} + 9 \text{ s OFF}$
Temperature rise	IEC/EN 61131-2; UL; CSA; ATEX; IECEx	Ambient temperature $60 \text{ }^\circ\text{C}/140 \text{ }^\circ\text{F}$ [for ruggedized range: $70 \text{ }^\circ\text{C}/158 \text{ }^\circ\text{F}$ ] (4)

(1) Devices must be installed, wired, and maintained in accordance with the instructions provided in the manual "Grounding and Electromagnetic Compatibility of PLC Systems" (see page 10/4).

(2) When using fast actuators (response time  $\leq 5 \text{ ms}$ ) driven by relay outputs:  $15 \text{ g}$ ,  $11 \text{ ms}$ ;  $3 \text{ shocks/direction/axis}$ .

(3) When using fast actuators (response time  $\leq 15 \text{ ms}$ ) driven by relay outputs:  $15 \text{ g}$ ,  $6 \text{ ms}$ ;  $100 \text{ bumps/direction/axis}$ .

(CE): Tests required by European CE directives and based on IEC/EN 61131-2 standards.

# Technical appendices

## Modicon automation product certifications and EC regulations

Some countries require certain electrical components to undergo certification by law. This certification takes the form of a certificate of conformity to the relevant standards and is issued by the official body in question. Where applicable, certified devices must be labeled accordingly. Use of electrical equipment on board merchant vessels generally implies that it has gained prior approval (i.e. certification) by certain shipping classification societies.









Abbreviation	Certification body / authority	Country
CE	European Community	European Union
UL	Underwriters Laboratories	USA
CSA	Canadian Standards Association	Canada
RCM	Australian Communications and Media Authority	Australia, New Zealand
EAC	Eurasian conformity	Russia and Eurasian Economic Union
UKCA	United Kingdom Central Authority	United Kingdom
cULus	Underwriters Laboratories	USA, Canada
cCSAus	Canadian Standards Association	Canada, USA
IECEX	International Electrotechnical Commission Explosive	International
ATEX	ATmosphères EXplosives	International
TÜV Rheinland (Functional Safety)	Technischer Überwachungsverein Rheinland	International
ABS	American Bureau of Shipping	USA
BV	Bureau Veritas	France
DNV	Det Norske Veritas	Norway, Germany
LR	Lloyd's Register	UK
RINA	Registro Italiano Navale	Italy
RMRS	Russian Maritime Register of Shipping	Russia
RRR	Russian River Register	Russia
CCS	China Classification Society	China
KRS	Korean Register of Shipping	Korea
Class NK	Nippon Kaiji Kyokai	Japan

**Note:** Although DNV GL rebranded to DNV as of March 1st, 2021, all certificates with DNV GL name and logo keep their initial validity date. Only rules in force on or after March 1st, 2021, are rebranded to DNV.

The following tables provide an overview of the situation as of March 2022, in terms of which certifications (listed next to their respective bodies) have been granted or are pending for our automation products.

Up-to-date information on which certifications have been obtained by products bearing the Schneider Electric brand can be viewed on our website [www.se.com](http://www.se.com).

### Product certifications

	Certifications								
	 CE	 UL	 CSA	 RCM	 EAC	 UKCA	 UL - CSA Hazardous locations (1)	 ATEX - IECEX	 TÜV Rheinland
	EU	USA	Canada	Australia	Russia	UK	USA, Canada	International	Germany
<b>Modicon STB</b>							Cl. I, Div. 2, Grps ABCD	Zone 2 (2) (4)	
<b>Modicon Telefast ABE 7</b>									
<b>Modicon Switch</b>			(3)				Cl. I, Div. 2, Grps ABCD (2)	Zone 2 (2)	
<b>Modicon MC80</b>							Cl. I, Div. 2, Grps ABCD		
<b>Modicon M340</b>							Cl. I, Div. 2, Grps ABCD	Zone 2/22 (2) (5)	
<b>Modicon M580</b>							Cl. I, Div. 2, Grps ABCD	Zone 2/22 (2) (5)	
<b>Modicon M580 Safety</b>							Cl. I, Div. 2, Grps ABCD	Zone 2/22 (2) (5)	SIL3, SILCL3, SIL4, Cat.4/PLe (6)
<b>Modicon X80</b>							Cl. I, Div. 2, Grps ABCD	Zone 2/22 (2) (5)	
<b>Modicon Momentum</b>							Cl. I, Div. 2, Grps ABCD		
<b>Modicon Quantum</b>					(2)		Cl. I, Div. 2, Grps ABCD	Zone 2/22 (2) (5)	

(1) Refer to user manual for installation in hazardous locations.

(2) Depends on product; Refer to the product certificates at [www.se.com](http://www.se.com).

(3) North American certification cULus (Canada and USA).

(4) For zones not covered by this specification, Schneider Electric offers a solution as part of the TPP (Technology Partner Program). Please contact our Customer Care Center.

(5) Certified by INERIS. Refer to the instructions supplied with each ATEX and/or IECEX certified product.











(6) Certified by TÜV Rheinland for integration into a Safety function:

- up to SIL2 or SIL3 regarding IEC61508/61511 for Process,
- up to SILCL3 regarding IEC62061 and up to Cat.4/PLe regarding ISO13849 for Machine,
- up to SIL4 regarding EN50126/50128/50129 for Railway.

# Technical appendices

## Modicon automation product certifications and EC regulations

### Merchant navy certifications

Certification status	Shipping classification societies									
										
	ABS	BV	DNV	LR	RINA	RMRS	RRR	CCS	KRS	Class NK
	USA	France	Norway/ Germany	Great Britain	Italy	Russia	Russia	China	Korea	Japan
Certified										
Certification pending										
Only part of range certified										
Modicon STB										
Modicon Telefast ABE 7										
Modicon Switch		(1)	(1)	(1)						
Modicon MC80										
Modicon M340										
Modicon M580										
Modicon M580 Safety										
Modicon X80										
Modicon Momentum										
Modicon Quantum										

### EC regulations

#### European Directives

The open nature of the European markets assumes harmonization between the regulations set by the member states of the European Union. European Directives are texts intended to remove restrictions on free circulation of goods and must be applied within all European Union states.

Member states are obligated to incorporate each Directive into their national legislation, and to simultaneously withdraw any regulations that contradict it.

Directives - and particularly those of a technical nature with which we are concerned - merely set out the objectives to be fulfilled (referred to as "essential requirements"). Manufacturers are responsible for taking the necessary measures to establish that their products conform to the requirements of each Directive applicable to their equipment.

As a general rule, manufacturers certify compliance with the essential requirements of the Directive(s) that apply to their products by applying a CE mark. The CE mark is affixed to our products where applicable.

#### Significance of the CE mark

The CE mark on a product indicates the manufacturer's certification that the product conforms to the relevant European Directives; this is a prerequisite for placing a product that is subject to the requirements of one or more Directives on the market and allowing its free circulation within European Union countries. The CE mark is intended for use by those responsible for regulating national markets.

Where electrical equipment is concerned, conformity to standards indicates that the product is fit for use. Only a warranty by a well-known manufacturer can provide reassurance of a high level of quality.

As far as our products are concerned, one or more Directives are likely to apply in each case, in particular:

- The Low Voltage Directive (2014/35/EU)
- The Electromagnetic Compatibility Directive (2014/30/EU)
- The ATEX CE Directive (2014/34/EU)
- The Machinery Directive (2006/42/EU)

#### Hazardous substances

These products are compatible with:

- The WEEE Directive (2012/19/EU)
- The RoHS Directive (2011/65/EU)
- The China RoHS Directive (Standard GB/T 26572-2011)
- REACH regulations (EC No. 1907/2006)

**Note:** Documentation on sustainable development is available on our website [www.se.com](http://www.se.com) (product environmental profiles and instructions for use, RoHS and REACH directives).

#### End of life (WEEE)

End of life products containing electronic cards must be dealt with by specific treatment processes.

When products containing backup batteries are unusable or at end of life they must be collected and treated separately. Batteries do not contain a percentage by weight of heavy metals above the limit specified by European Directive 2013/56/EU.

(1) Please refer to Modicon Networking catalog for more details.

# Dedicated service offers for your installed base



Schneider Electric, with its experts, products, and dedicated tools, provides services such as system design, consultancy, maintenance contracts, modernization of facilities, and project delivery.

The Schneider Electric services offer is structured around several key areas:

- Maintenance and support services:
  - A set of services to help maintain reliability and availability of automated control systems. These services may be the subject of a bespoke maintenance contract to meet your requirements more closely.
- Consultancy services:
  - Diagnostics of the installed base
- Modernization solutions:
  - Migration solutions including consultancy, expertise, tools, and technical support to help ensure a smooth transition to newer technology while retaining the wiring and encoding in most cases.

Customization services are also available to accommodate specific requirements. For more information, please consult the [specific pages on our website](#).

## Maintenance and support services

### Spare parts, exchanges, and repairs

#### *Everything you need to get equipment working again as quickly as possible*

Solutions to respond very quickly to requests for spare parts, exchanges, and repairs to your installed automation equipment (automation platforms, Human Machine Interfaces, drives, distributed I/O):

- Spare parts management:
  - Identification of critical parts
  - Stock of spare parts: a Schneider Electric owned stock of spare parts, on your site or in one of our warehouses, with immediate availability on site or a contractually agreed delivery time if stored off site
  - Testing of spare parts stored on site
  - Automatic stock filling
- Repairs:
  - Products that have broken down are repaired in a network of worldwide repair centers. For each repaired product, our experts provide a detailed report.
- On-site repair:
  - Our experts' knowledge and expertise
  - Monitoring of specific repair procedures
  - Availability of our teams to respond 24/7
- Exchanges:
  - With standard replacements, receive a new or reconditioned product before the product that has broken down has even been sent back
  - Fast exchanges offer the option to receive the replacement product within 24 hours (in Europe)

### Preventive maintenance

#### *Improving and helping to ensure the long-term reliability and performance of your installations*

Schneider Electric's preventive maintenance expert assesses your site and the equipment to be managed and sets up a maintenance program to accommodate your specific requirements. A list is provided of the tasks to be performed and their frequency, including site-specific tasks, describing how preventive maintenance is to be managed.

### Extended warranty

#### *An additional manufacturer warranty covering replacement or repair of the equipment*

The extended warranty offers the option to take out a 3-year warranty. The warranty period can vary according to the geographical area (please contact our Customer Care Center for more information).

### Online support

#### *Access to dedicated experts*

Priority access to experts who can answer technical questions promptly concerning equipment and software both on sale and no longer commercially available.

### Software subscription

#### *Access to software upgrades and new features*

By subscribing to software updates, users are able to:

- Purchase licences
- Receive updates, upgrades, software migrations, and transitions
- Download software from Schneider Electric's software library

## Consultancy services

### M2C (Maintenance and Modernization Consultancy)

*Professional tools and methods, proven experience of managing obsolescence and updating installed bases, helping to reduce downtime and improve performance*

With our maintenance and modernization consultancy offer, Schneider Electric will help you check the state of your installed base by:

- Defining the scope and depth of the analysis in collaboration with you
- Collecting the technical data without shutting down production
- Analyzing and identifying avenues for improvement
- Producing a recommendation plan

Customer benefits:

- Learning about the components that make up the installed base and what their life cycle state is (i.e. commercialized or obsolete)
- Better downtime anticipation
- Expert advice designed to improve performance

## Modernization solutions

### Migration to EcoStruxure

*Proven expertise, tools, and methods to give you a clear vision of the improvement opportunities and guide you towards a successful modernization project*



Find out more about EcoStruxure architectures on our website [www.se.com](http://www.se.com)

Schneider Electric offers gradual solutions of modernization through a set of products, tools, and services that allow you to upgrade your installations with our latest technologies. Our solutions offer you the choice to plan your modernization:

- Partial modernization: replacement of an old set of components with a new one
- Step-by-step modernization: gradual incorporation of new solutions or offers in the system
- Complete modernization: total renovation of the system

The table below lists our various migration offers:

Wide range of migration offers		Moving to M580/M340/X80 platform						
Solution		Solution type			Tools	Solution services		
		Change the CPU and retain the I/O racks and wiring	Change the CPU and the I/O racks and retain I/O field wiring with wiring system	Change the CPU, the I/O racks, and the I/O wiring	SoftWare application conversion tool	Modernization/migration service	Manage your project	Execute your project
Platform	Premium	☑	☑	☑	☑	☑	☑	☑
	TSX47 to TSX107		☑	☑	☑	☑	☑	☑
	Quantum	☑	☑	☑	☑	☑	☑	☑
	Modicon 984 & 800 Series I/O	☑	☑	☑	☑	☑	☑	☑
	Modicon Compact		☑	☑	☑	☑	☑	☑
	Symax	☑	(1)	☑	☑	☑	☑	☑
	April Series 1000		(2)	☑	☑	☑	☑	☑
	April SMC			☑	☑	☑	☑	☑
	Merlin Gerin PB			☑		☑	☑	☑
	AEG		(1)	☑		☑	☑	☑
	Rockwell SLC500		☑	☑	☑	☑	☑	☑
	Rockwell PLC 5	☑	☑	☑	☑	☑	☑	☑
	Siemens S5 and S7			☑	☑	☑	☑	☑

☑ Service available

(1) Consult Schneider Services - project-specific solution is possible  
 (2) For April Series 1000 (April 5000-7000 and April 2000-3000)  
 Consult Schneider Services - project-specific solution is possible

## Customization services

Schneider Electric is able to meet your specific requirements and provide you with adapted products:

- Protective coating for HMIs, automation platforms, and distributed I/O modules for use in harsh environments
- Customized cable lengths to match your specific needs
- Customized front panels for HMIs
- The multi-use flying lead I/O adapter can be prepared in the factory before use on request.

**Note:** To check availability of services required, please contact our Customer Care Center.

A	
ABE7CPA02	4/25
ABE7CPA03	4/25
ABE7CPA21	4/25
ABE7CPA31	4/25
ABE7CPA31E	4/25
ABE7CPA410	4/25
ABE7CPA412	4/25

B	
BMEAHI0812	4/28
BMEAHI0812H	9/7
BMEAHO0412	4/28
BMEAHO0412C	9/7
BMECRA31210	7/4
BMECRA31210C	9/9
BMECXM0100	8/9
BMECXM0100H	9/9
BMENOS0300	8/15
BMENOS0300C	9/9
BMEXBP0400	2/4
BMEXBP0400H	9/4
BMEXBP0602	2/4
BMEXBP0602H	9/4
BMEXBP0800	2/4
BMEXBP0800H	9/4
BMEXBP1002	2/4
BMEXBP1002H	9/4
BMEXBP1200	2/4
BMEXBP1200H	9/4
BMXAMI0410	4/24
BMXAMI0410H	9/7
BMXAMI0800	4/24
BMXAMI0810	4/24
BMXAMI0810H	9/7
BMXAMM0600	4/24
BMXAMM0600H	9/7
BMXAMO0210	4/24
BMXAMO0210H	9/7
BMXAMO0410	4/24
BMXAMO0410H	9/7
BMXAMO0802	4/24
BMXAMO0802H	9/7
BMXART0414	4/24
BMXART0414H	9/7
BMXART0814	4/24
BMXART0814H	9/7
BMXCPS2000	3/3
BMXCPS2010	3/3
BMXCPS3020	3/3
BMXCPS3020H	9/5
BMXCPS3500	3/3
BMXCPS3500H	9/5
BMXCPS3522	3/3
BMXCPS3522H	9/5
BMXCPS3522S	5/7
BMXCPS3540T	3/3
BMXCPS4002	3/3
BMXCPS4002H	9/5
BMXCPS4002S	5/7
BMXCPS4022	3/3
BMXCPS4022H	9/5
BMXCPS4022S	5/7
BMXCRA31200	7/4

BMXCRA31210	7/4
BMXCRA31210C	9/9
BMXDAI0805	4/13
BMXDAI0814	4/13
BMXDAI1602	4/13
BMXDAI1602H	9/6
BMXDAI1602H	9/6
BMXDAI1603	4/13
BMXDAI1603H	9/6
BMXDAI1604	4/13
BMXDAI1604H	9/6
BMXDAI1614	4/13
BMXDAI16142	4/13
BMXDAI1614H	9/6
BMXDAI1615	4/13
BMXDAI1615H	9/6
BMXDAO1605	4/14
BMXDAO1605H	9/6
BMXDAO1615	4/14
BMXDAO1615H	9/6
BMXDDI1602	4/13
BMXDDI1602H	9/6
BMXDDI1603	4/13
BMXDDI1603H	9/6
BMXDDI1604T	4/13
BMXDDI3202K	4/13
BMXDDI3202KH	9/6
BMXDDI3203	4/13
BMXDDI3203H	9/6
BMXDDI3232	4/13
BMXDDI3232H	9/6
BMXDDI6402K	4/13
BMXDDI6402KH	9/6
BMXDDM16022	4/14
BMXDDM16022H	9/7
BMXDDM16025	4/14
BMXDDM16025H	9/7
BMXDDM3202K	4/14
BMXDDO1602	4/14
BMXDDO1602H	9/6
BMXDDO1612	4/14
BMXDDO1612H	9/6
BMXDDO3202K	4/14
BMXDDO3202KC	9/6
BMXDDO6402K	4/14
BMXDDO6402KC	9/6
BMXDRA0804T	4/14
BMXDRA0805	4/14
BMXDRA0805H	9/6
BMXDRA0815	4/14
BMXDRA0815H	9/6
BMXDRA1605	4/14
BMXDRA1605H	9/6
BMXDRC0805	4/14
BMXDRC0805H	9/6
BMXEAE0300	6/9
BMXEAE0300H	9/8
BMXEHC0200	6/5
BMXEHC0200H	9/8
BMXEHC0800	6/5
BMXEHC0800H	9/8
BMXEIA0100	8/5
BMXERT1604H	6/7

BMXERT1604T	6/7
BMXETM0200H	6/15
	9/8
BMXFCA150	4/25
BMXFCA152	4/25
BMXFCA300	4/25
BMXFCA302	4/25
BMXFCA500	4/25
BMXFCA502	4/25
BMXFCC051	4/15
BMXFCC053	4/15
BMXFCC1001	4/15
BMXFCC1003	4/15
BMXFCC101	4/15
BMXFCC103	4/15
BMXFCC201	4/15
BMXFCC203	4/15
BMXFCC301	4/15
BMXFCC303	4/15
BMXFCC501	4/15
BMXFCC503	4/15
BMXFCW1001	4/15
BMXFCW1003	4/15
BMXFCW301	4/15
BMXFCW301S	4/25
BMXFCW303	4/15
BMXFCW501	4/15
BMXFCW501S	4/25
BMXFCW503	4/15
BMXFTA150	4/25
BMXFTA152	4/25
BMXFTA300	4/25
BMXFTA302	4/25
BMXFTB2000	4/15
	4/25
	5/10
	5/11
	6/5
BMXFTB2010	4/15
	4/25
	5/10
	5/11
	6/5
BMXFTB2020	4/15
	4/25
	5/10
	5/11
	6/5
BMXFTB2800	4/25
	6/7
	6/9
	6/11
BMXFTB2820	4/25
	6/7
	6/9
	6/11
BMXFTB4000	4/15
BMXFTB4000H	9/8
BMXFTB4020	4/15
BMXFTB4020H	9/8
BMXFTW1001	4/15
BMXFTW301	4/15
BMXFTW301S	4/25
BMXFTW305	4/15
BMXFTW308S	4/25
BMXFTW501	4/15
BMXFTW501S	4/25
BMXFTW505	4/15

BMXFTW508S	4/25
BMXMSP0200	6/11
BMXNOM0200	8/7
BMXNOM0200H	9/9
BMXNRP0200	8/14
BMXNRP0200C	9/9
BMXNRP0201	8/14
BMXNRP0201C	9/9
BMXPRA0100	7/7
BMXSAI0410	5/11
BMXSDI1602	5/10
BMXSDO0802	5/10
BMXSRA0405	5/10
BMXXBC008K	2/9
BMXXBC015K	2/9
BMXXBC030K	2/9
BMXXBC050K	2/9
BMXXBC120K	2/9
BMXXBE1000	2/9
BMXXBE1000H	9/4
BMXXBE2005	2/9
BMXXBP0400	2/4
BMXXBP0400H	9/4
BMXXBP0600	2/4
BMXXBP0600H	9/4
BMXXBP0800	2/4
BMXXBP0800H	9/4
BMXXBP1200	2/4
BMXXBP1200H	9/4
BMXXEM010	2/5
BMXXSP0400	2/5
BMXXSP0600	2/5
BMXXSP0800	2/5
BMXXSP1200	2/5
BMXXTSCPS10	3/3
	5/7
BMXXTSCPS20	3/3
	5/7
BMXXTSHSC20	6/5
P	
PMEPXM0100	8/11
PMEPXM0100H	9/9
PMESWT0100	6/17
S	
STBXSP3010	2/5
STBXSP3020	2/5
T	
TCSEGDB23F24FA	8/13
TCSEGDB23F24FK	9/9
TCSEGA23F14FK	9/9
TCSMCN3M4F3C2	8/7
TCSMCN3M4M3S2	8/7
	9/9
TCSXCN3M4F3S4	8/7
	9/9
TSXCBY010K	2/9
TSXCBY030K	2/9
TSXCBY050K	2/9
TSXCBY1000	2/9
TSXCBY120K	2/9
TSXCBY180K	2/9
TSXCBY280KT	2/9
TSXCBYACC10	2/9

TSXCBYK9	2/9
TSXTLYEX	2/9
V	
VW3M8223R30	6/11



Life Is On



Learn more about our products at  
[www.se.com](http://www.se.com)

The information provided in this documentation contains general descriptions and/or technical characteristics of the performance of the products contained herein. This documentation is not intended as a substitute for and is not to be used for determining suitability or reliability of these products for specific user applications. It is the duty of any such user or integrator to perform the appropriate and complete risk analysis, evaluation and testing of the products with respect to the relevant specific application or use thereof. Neither Schneider Electric nor any of its affiliates or subsidiaries shall be responsible or liable for misuse of the information contained herein.

Design: Schneider Electric  
Photos: Schneider Electric

**Schneider Electric Industries SAS**

Head Office  
35, rue Joseph Monier - CS 30323  
F-92500 Rueil-Malmaison Cedex  
France

DIA6ED2131203EN  
March 2022 - V13.0