

MONA 4

WQJP05140

LED luminaire MONA 4, with a power of 35 W, high light efficacy 115 lm/W. It is made of high-quality components, supported by a 5-year warranty. It also stands out for its very high colour rendering index RA>90. Lights up with neutral light - the most universal colour (4000K), which is suitable for the rooms we use on a daily basis, ensuring comfort during everyday activities. Narrow beam angle 60° gives directional light so that selected objects or surfaces can be better exposed. Designed for recessed mounting.



Power	35 W	Voltage	230 V
Colour temperature	4000 K	Colour of light	Neutral white
Beam angle	60 °	Degree of protection (IP)	IP20

Technical data

Code	WQJP05140
Power	35 W
Nominal current	167.4 mA
Voltage	230 V
Energy consumption	35 kWh/1000h
Frequency	50HZ Hz
Protection class	II
Power supply included	+
Manufacturer of power supply	OSRAM
Power factor	0.93
Useful luminous flux*	4025 lm (360°)
Luminous flux**	3500 lm (360°)
Lamp efficacy	115 lm/W
Colour temperature	4000 K
Colour of light	Neutral white
Beam angle	60 °
RA	90
Light source included	+
Producer of LED diodes	CREE
Uniformity of color SDCM max	3
Dimmable	DALI
Working temperature range	-20/+40 °
Lifespan	50000 h
Housing material	Aluminum
Degree of protection (IP)	IP20
Colour	White
Dimension (AxBxC)	193x130 mm
Mounting hole	Ø160 mm
For use	Inside
Assembly method	Recessed
Application	Inside
Made in	PL

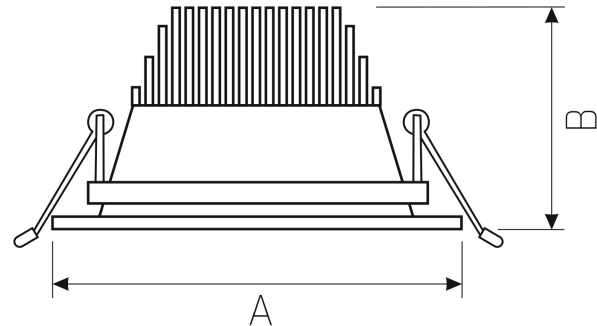

Related documents



 Photometric file