

Miniature photoelectric sensors in M5 and M6 sized housing

E3T-C





The E3T-C family of miniature photoelectric sensors is the ideal solution when mounting space is crucial.

- axial and radial M5 sized through-beam sensors
- axial M6 sized diffuse-reflective sensors
- pre-wired models in stainless steel housing



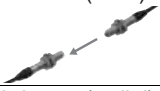

Ordering Information



M5 cylindrical housing Red light Infrared light

Sensor type	Sensing distance	Operation mode	Order code	
			NPN output	PNP output
 Through-beam (axial)	 1 m	Dark-ON	E3T-CT12 2M	E3T-CT14 2M
 Through-beam (radial)	 500 mm	Dark-ON	E3T-CT22S 2M	E3T-CT24S 2M

M6 cylindrical housing Red light Infrared light

Sensor type	Sensing distance	Operation mode	Order code	
			NPN output	PNP output
 Diffuse-reflective	 3 to 50 mm	Light-ON	E3T-CD11 2M	E3T-CD13 2M

Ratings and Specifications

Item		Through-beam		Diffuse-reflective
		Cylindrical type (Top-view)	Cylindrical type (Side-view)	Cylindrical type (Top-view)
				
NPN output	Light-ON	---	---	E3T-CD11
	Dark-ON	E3T-CT12	E3T-CT22S	---
PNP output	Light-ON	---	---	E3T-CD13
	Dark-ON	E3T-CT14	E3T-CT24S	---
Sensing distance		1 m	500 mm	3 to 50 mm (100 × 100 mm white paper)
Standard sensing object		Opaque, 4-mm dia. min.	Opaque, 5-mm dia. min.	---
Hysteresis (white paper)		---		15% or less of the sensing distance
Directional angle		Receiver: 2°	Receiver: 10°	---
Light source (wavelength)		Red LED (630 nm)	Red LED (625 nm)	Infrared LED (870 nm)
Power supply voltage		12 to 24 VDC ±10%, ripple (p-p) 10% max.		
Current consumption		30 mA max. (Emitter 15 mA max., Receiver 15 mA max.)		20 mA max.
Control output		Load power supply voltage: 30 VDC max. Load current: 80 mA max. (residual voltage: 1 V max.) Open-collector output		
Protection circuits		Power supply reverse polarity protection, Output short-circuit protection		
Response time		Operate or reset: 0.5 ms max.		
Ambient illumination		Incandescent lamp: 3,000 lx max.		
Ambient temperature range		Operating: -25 to +55°C Storage: -30 to +70°C (with no icing or condensation)		
Ambient humidity range		Operating or Storage: 35% to +85% (with no condensation)		
Insulation resistance		20 MΩ min. at 500 VDC		
Dielectric strength		500 VAC, 50/60 Hz for 1 min.		
Vibration resistance (destruction)		10 to 55Hz, 1.5-mm double amplitude for 2 hours each in X, Y, and Z directions		
Shock resistance (destruction)		500 m/s ² 3 times each in X, Y, and Z directions		
Degree of protection		IP65 (IEC 60529)		
Connection method		Pre-wired (standard length: 2 m)		
Weight (packed state)		Approx. 60 g	Approx. 40 g	
Materials	Case	SUS303		
	Display window	Polysulfone	Epoxy	
	Lens	Polysulfone		
	Hexagonal nuts	SUS303		
	Toothed washers	SUS303		
Accessories		Instruction manual, Hexagonal nuts, Toothed washers		Instruction manual, Hexagonal nuts, Toothed washers, Adjustment driver

Engineering Data (Typical)

Parallel Operating Range

Through-beam

E3T-CT1□

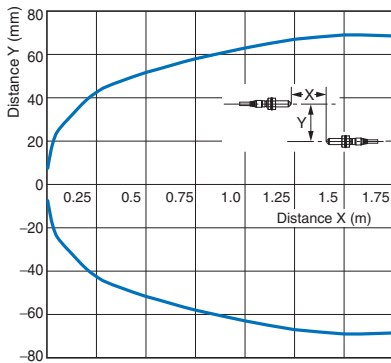

E3T-CT2□S (Top to Bottom)

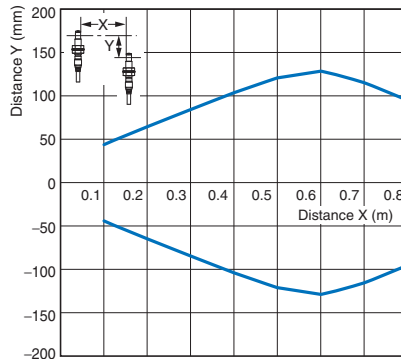

E3T-CT2□S (Right to Left)

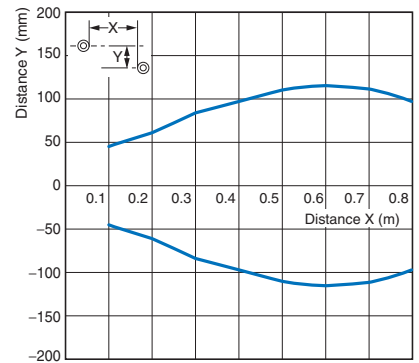

Operating Range

Diffuse-reflective

E3T-CD1□

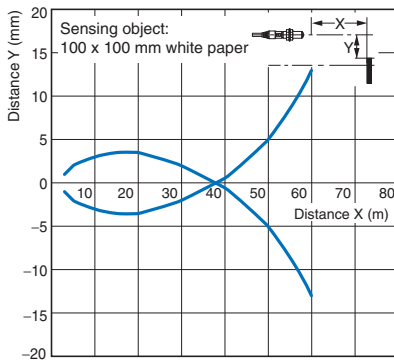

Sensing Distance vs. Material

Diffuse-reflective

E3T-CD1□

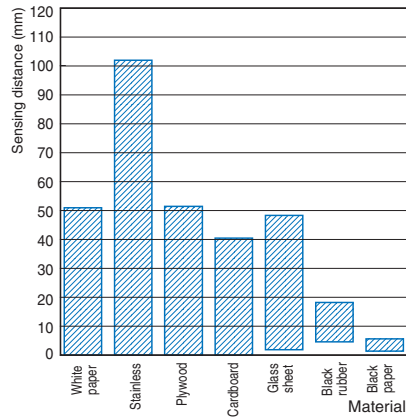

I/O Circuit Diagrams

NPN Output

Model	Operation mode	Timing charts	Output circuit
E3T-CD11	Light-ON	<p>Light incident Light interrupted</p> <p>Operation indicator (orange) ON OFF</p> <p>Output transistor ON OFF</p> <p>Load (e.g., relay) Operate Reset</p> <p>(Between brown (1) and black (4) leads)</p>	<p>Through-beam Receivers and Reflective Sensors</p> <p>Operation indicator (orange) Stability indicator (green) Photo-electric Sensor Main Circuit (Control output) Brown 12 to 24 VDC Black 80 mA max. Load (relay) Blue 0 V</p>
E3T-CT12 E3T-CT22S	Dark-ON	<p>Light incident Light interrupted</p> <p>Operation indicator (orange) ON OFF</p> <p>Output transistor ON OFF</p> <p>Load (e.g., relay) Operate Reset</p> <p>(Between brown (1) and black (4) leads)</p>	<p>Through-beam Emitters</p> <p>Photo-electric Sensor Main Circuit Brown 12 to 24 VDC Blue</p>

PNP Output

Model	Operation mode	Timing charts	Output circuit
E3T-CD13	Light-ON	<p>Light incident Light interrupted</p> <p>Operation indicator (orange) ON OFF</p> <p>Output transistor ON OFF</p> <p>Load (e.g., relay) Operate Reset</p> <p>(Between blue (3) and black (4) leads)</p>	<p>Through-beam Receivers and Reflective Sensors</p> <p>Operation indicator (orange) Stability indicator (green) Photo-electric Sensor Main Circuit (Control output) Brown 12 to 24 VDC Black 80 mA max. Load (relay) Blue 0 V</p>
E3T-CT14 E3T-CT24S	Dark-ON	<p>Light incident Light interrupted</p> <p>Operation indicator (orange) ON OFF</p> <p>Output transistor ON OFF</p> <p>Load (e.g., relay) Operate Reset</p> <p>(Between blue (3) and black (4) leads)</p>	<p>Through-beam Emitters</p> <p>Photo-electric Sensor Main Circuit Brown 12 to 24 VDC Blue</p>

Safety Precautions

Refer to *Warranty and Limitations of Liability*.

WARNING

This product is not designed or rated for ensuring safety of persons. Do not use it for such purpose.



Do not apply AC power to the E3T, otherwise the E3T may rupture.



Precautions for Correct Use

Do not use the product in atmospheres or environments that exceed product ratings.

Wiring

The maximum power supply voltage is 26.4 VDC. Before turning the power ON, make sure that the power supply voltage be not more than maximum voltage.

Load short-circuit protection

The E3T incorporates a load short-circuit protection function. If the load short-circuits, the output of the E3T will be turned OFF. Then, recheck the wiring and turn on the E3T again to reset the load short-circuit protection function. The load short-circuit protection function will work if there is a current flow that is 1.5 times larger than the rated load current. When using a capacitance load, be sure that the inrush current will not exceed 1.5 times larger than the rated current.

Mounting

When mounting the Sensor, never strike it with a heavy object, such as a hammer. Doing so may reduce its watertight properties. Use screws with spring, flat, or toothed washers to secure the Sensor. Tightening Torque Small Cylindrical Sensors: 1 N·m max

Mounting the Sensor on Moving Parts

Consider models that use break resistant cables (e.g., Robotics Cables) if the Sensor will be mounted on a moving part, such as a robot hand. The flexing resistance of Robotics Cable at approximately 400 thousand times is far superior to that of standard cable at approximately 14 thousand times.

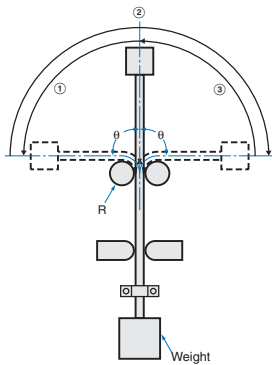

Cable Bending Rupture Test (Tough Cable Breaking Test)

The cable is repeatedly bent with power supplied to check the number of bends until the current is turned OFF.

Test		Specimen	Standard cable 2.4-mm dia. (7/0.127-mm dia.), 3 conductors	Robotics cable 2.4-mm dia. (20/0.08-mm dia.), 3 conductors
Con- tents/ condi- tions	Bending angle (θ)		90° each to the left and right	
	Bending speed		50 times/min	
	Load		200 g	
	Operation per bend		Once in 1 to 3 in the diagram	
	Curvature radius of support point (R)		5 mm	
Result			Approx. 14,000 times	Approx. 400,000 times

Adjusting

Indicators

- The following graphs indicate the status of each operating level.
- Be sure to use the E3T within the stable operating range.

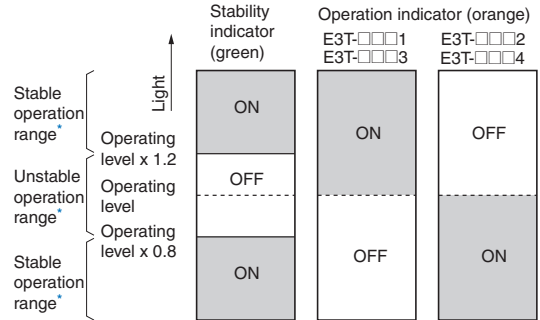

* If the E3T fs operating level is set to the stable operation range, the E3T will be in most reliable operation without being influenced by temperature change, voltage fluctuation, dust, or setting change. If the operating level cannot be set to the stable operation range, pay attention to environmental changes while operating the E3T.

E3T-CD□□ Sensitivity Adjustment

Use the special screwdriver that is provided with the Sensor to adjust the sensitivity. Do not exceed 0.8 N·m when turning the adjuster.

Others

Do not install the E3T in the following locations.

- Locations subject to excessive dust or dirt
- Locations subject to direct sunlight
- Locations subject to corrosive gas
- Locations subject to contact with organic solvents
- Locations subject to vibration and shock
- Locations subject to contact with water, oil, or chemicals
- Locations subject to high humidities that might result in condensation

Dimensions

(Unit: mm)

Tolerance class IT16 applies to dimensions in this datasheet unless otherwise specified.

Small Cylindrical Sensors
Through-beam Top-view Sensors
E3T-CT1□ (Emitter)

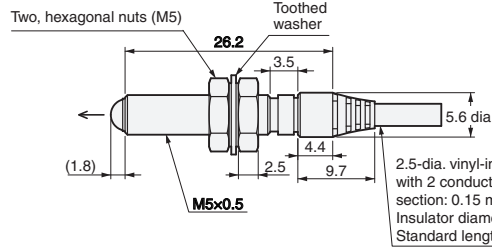
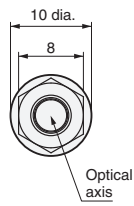
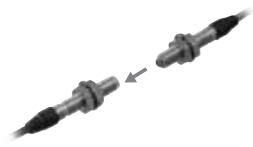

Mounting Hole



Emitter: E3T-CT1□-L
Receiver: E3T-CT1□-D

E3T-CT1□ (Receiver)

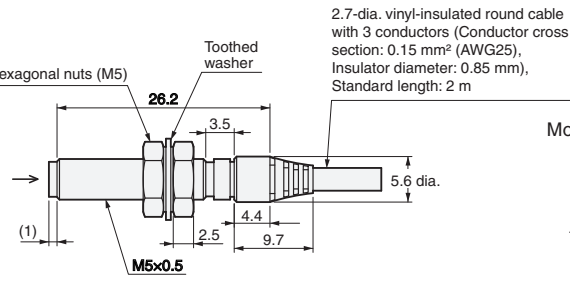
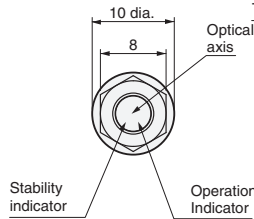

Mounting Hole

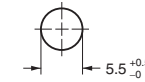

Through-beam Side-view Sensors
E3T-CT2□S (Emitter)

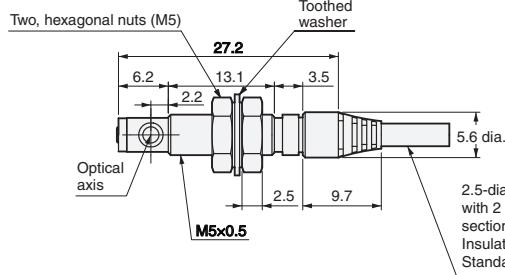
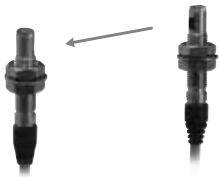

Mounting Hole



Emitter: E3T-CT2□S-L
Receiver: E3T-CT2□S-D

E3T-CT2□S (Receiver)

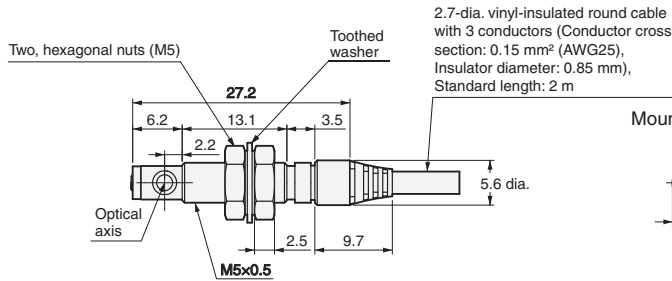
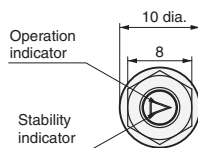

Mounting Hole

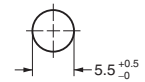

Diffuse-reflective Top-view Sensors
E3T-CD1□

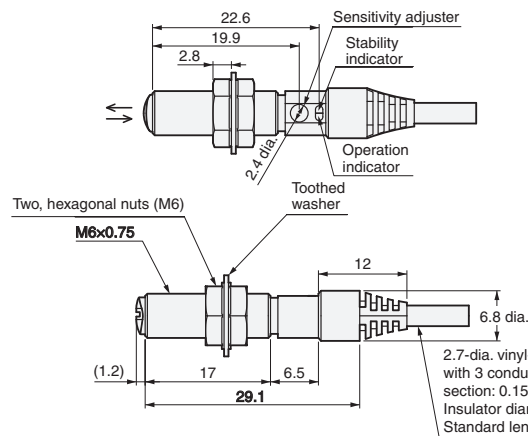
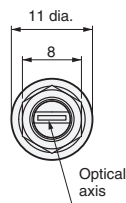

Mounting Hole

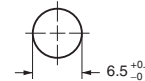

READ AND UNDERSTAND THIS DOCUMENT

Please read and understand this document before using the products. Please consult your OMRON representative if you have any questions or comments.

WARRANTY

OMRON's exclusive warranty is that the products are free from defects in materials and workmanship for a period of one year (or other period if specified) from date of sale by OMRON.

OMRON MAKES NO WARRANTY OR REPRESENTATION, EXPRESS OR IMPLIED, REGARDING NON-INFRINGEMENT, MERCHANTABILITY, OR FITNESS FOR PARTICULAR PURPOSE OF THE PRODUCTS. ANY BUYER OR USER ACKNOWLEDGES THAT THE BUYER OR USER ALONE HAS DETERMINED THAT THE PRODUCTS WILL SUITABLY MEET THE REQUIREMENTS OF THEIR INTENDED USE. OMRON DISCLAIMS ALL OTHER WARRANTIES, EXPRESS OR IMPLIED.

LIMITATIONS OF LIABILITY

OMRON SHALL NOT BE RESPONSIBLE FOR SPECIAL, INDIRECT, OR CONSEQUENTIAL DAMAGES, LOSS OF PROFITS OR COMMERCIAL LOSS IN ANY WAY CONNECTED WITH THE PRODUCTS, WHETHER SUCH CLAIM IS BASED ON CONTRACT, WARRANTY, NEGLIGENCE, OR STRICT LIABILITY.

In no event shall responsibility of OMRON for any act exceed the individual price of the product on which liability is asserted.

IN NO EVENT SHALL OMRON BE RESPONSIBLE FOR WARRANTY, REPAIR, OR OTHER CLAIMS REGARDING THE PRODUCTS UNLESS OMRON'S ANALYSIS CONFIRMS THAT THE PRODUCTS WERE PROPERLY HANDLED, STORED, INSTALLED, AND MAINTAINED AND NOT SUBJECT TO CONTAMINATION, ABUSE, MISUSE, OR INAPPROPRIATE MODIFICATION OR REPAIR.

SUITABILITY FOR USE

THE PRODUCTS CONTAINED IN THIS DOCUMENT ARE NOT SAFETY RATED. THEY ARE NOT DESIGNED OR RATED FOR ENSURING SAFETY OF PERSONS, AND SHOULD NOT BE RELIED UPON AS A SAFETY COMPONENT OR PROTECTIVE DEVICE FOR SUCH PURPOSES. Please refer to separate catalogs for OMRON's safety rated products.

OMRON shall not be responsible for conformity with any standards, codes, or regulations that apply to the combination of products in the customer's application or use of the product.

At the customer's request, OMRON will provide applicable third party certification documents identifying ratings and limitations of use that apply to the products. This information by itself is not sufficient for a complete determination of the suitability of the products in combination with the end product, machine, system, or other application or use.

The following are some examples of applications for which particular attention must be given. This is not intended to be an exhaustive list of all possible uses of the products, nor is it intended to imply that the uses listed may be suitable for the products:

- Outdoor use, uses involving potential chemical contamination or electrical interference, or conditions or uses not described in this document.
- Nuclear energy control systems, combustion systems, railroad systems, aviation systems, medical equipment, amusement machines, vehicles, safety equipment, and installations subject to separate industry or government regulations.
- Systems, machines, and equipment that could present a risk to life or property.

Please know and observe all prohibitions of use applicable to the products.

NEVER USE THE PRODUCTS FOR AN APPLICATION INVOLVING SERIOUS RISK TO LIFE OR PROPERTY WITHOUT ENSURING THAT THE SYSTEM AS A WHOLE HAS BEEN DESIGNED TO ADDRESS THE RISKS, AND THAT THE OMRON PRODUCT IS PROPERLY RATED AND INSTALLED FOR THE INTENDED USE WITHIN THE OVERALL EQUIPMENT OR SYSTEM.

PERFORMANCE DATA

Performance data given in this document is provided as a guide for the user in determining suitability and does not constitute a warranty. It may represent the result of OMRON's test conditions, and the users must correlate it to actual application requirements. Actual performance is subject to the OMRON Warranty and Limitations of Liability.

CHANGE IN SPECIFICATIONS

Product specifications and accessories may be changed at any time based on improvements and other reasons.

It is our practice to change model numbers when published ratings or features are changed, or when significant construction changes are made. However, some specifications of the product may be changed without any notice. When in doubt, special model numbers may be assigned to fix or establish key specifications for your application on your request. Please consult with your OMRON representative at any time to confirm actual specifications of purchased products.

DIMENSIONS AND WEIGHTS

Dimensions and weights are nominal and are not to be used for manufacturing purposes, even when tolerances are shown.

ERRORS AND OMISSIONS

The information in this document has been carefully checked and is believed to be accurate; however, no responsibility is assumed for clerical, typographical, or proofreading errors, or omissions.

PROGRAMMABLE PRODUCTS

OMRON shall not be responsible for the user's programming of a programmable product, or any consequence thereof.

COPYRIGHT AND COPY PERMISSION

This document shall not be copied for sales or promotions without permission.

This document is protected by copyright and is intended solely for use in conjunction with the product. Please notify us before copying or reproducing this document in any manner, for any other purpose. If copying or transmitting this document to another, please copy or transmit it in its entirety.

Cat. No. E70E-EN-01

In the interest of product improvement, specifications are subject to change without notice.

OMRON EUROPE B.V.

Wegalaan 67-69,
NL-2132 JD, Hoofddorp,
The Netherlands
Phone: +31 23 568 13 00
Fax: +31 23 568 13 88
www.industrial.omron.eu