

75009709	DATA SHEET	
Valid from: 31.10.2018	EPIC[®] SIGNAL M23 KIT F6 17 PIN SOLDER TERMINATION	

Description

- Circular connector for servo cables and encoders
- Low-resistance screen contact
- Optimum EMC protection
- Use of high quality materials for increased reliability
- Complete connector with housing and insulation body, equipped with suitable solder contacts



Components of the combination

Article number of the combination	75009709
Housing	SIGNAL M23 F6 (44420040)
Insert	17 Pin (E-Part) with solder termination (73028500)

General characteristics

Series	SIGNAL M23
Type	F6, Coupling connector
Version	Male
Connection type	Solder termination
Coding	Black (N)
Pin-arrangement	17 (E-Part)
Contact diameter	1 mm
Termination cross section	Up to 1 mm ²
Clamping range	7,0 mm – 13,5 mm
Degree of protection	IP 68 (10 h / 1 m) (latched)
Cycles of mechanical operation	100
Temperature range	-25 °C to +125 °C

Materials and surfaces

Housing, base material	Zinc die-cast
Housing, surface	Nickel
Sealing	FPM/FKM
Insert	PA
Contact, base material	Brass
Contact, surface	Gold

Electrical characteristics

Rated voltage	50 V
Rated impulse voltage	0,8 kV
Rated current	7 A
Contact resistance	< 4 mOhm
Verschmutzungsgrad	3

Creator: STKU3/PDP Released: IVSE1/PDP	Document: DB75009709EN Version: 00	Page 1 of 3
---	---------------------------------------	-------------

75009709	DATA SHEET	
Valid from: 31.10.2018	EPIC[®] SIGNAL M23 KIT F6 17 PIN SOLDER TERMINATION	

Approvals

VDE-Approval, VDE-REG.-Nr.
UL File Number

C024
E249137



Standards

Safety Standard

IEC 61984; UL1977

Technical Drawings

Housing

Anzugsdrehmoment: 7,5 Nm
tightening torque: 7,5 Nm

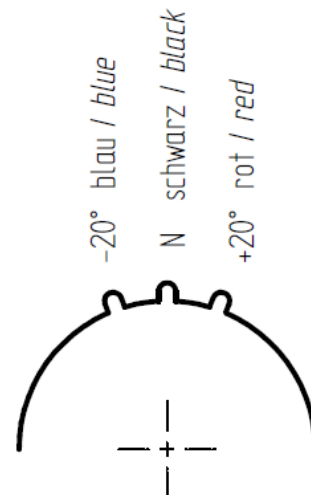
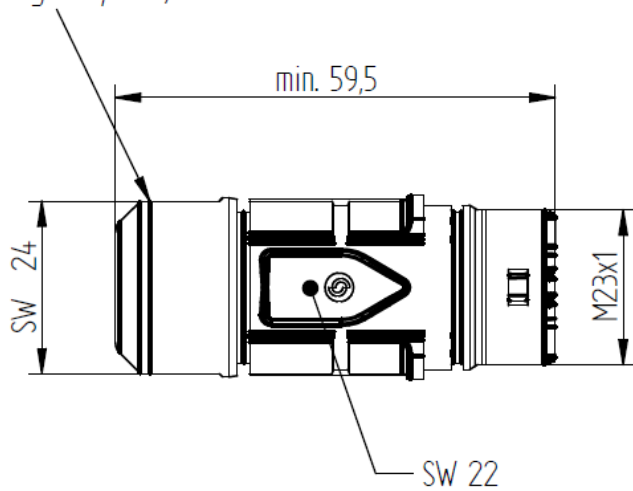

A1/F6
Ansicht steckseitig
view from mating side

Insert

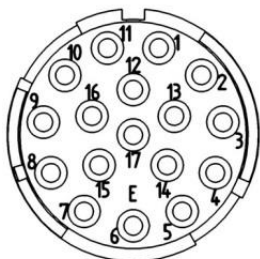

Creator: STKU3/PDP Released: IVSE1/PDP	Document: DB75009709EN Version: 00	Page 2 of 3
---	---------------------------------------	-------------

75009709	DATA SHEET	
Valid from: 31.10.2018	EPIC[®] SIGNAL M23 KIT F6 17 PIN SOLDER TERMINATION	



Good chemical resistance

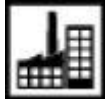

Industrial machinery and plant engineering

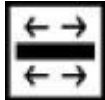

Optimum strain relief



Mechanical resistance



Assembly time



Robust



Integrated SKINTOP[®] cable gland



Wind energy



Variety of approval certifications

Info

Robust metal connector with integrated EMC cable gland

Application range

Plant engineering
 Servo drives and Servo assemblies
 Measurement and control technology
 Apparatus construction

Remark

Photographs are not to scale and do not represent detailed images of the respective products.

Creator: STKU3/PDP Released: IVSE1/PDP	Document: DB75009709EN Version: 00	Page 3 of 3
---	---------------------------------------	-------------