

Time switch

GB

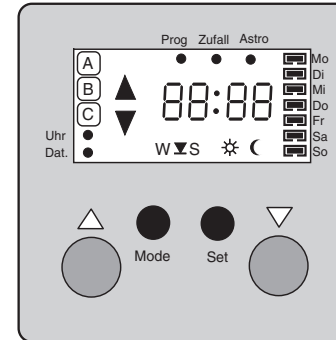

Schneider Industries SAS

If you have technical questions, please contact the Customer Care Center in your country.

www.schneider-electric.com

This product must be installed, connected and used in compliance with prevailing standards and/or installation regulations. As standards, specifications and designs develop from time to time, always ask for confirmation of the information given in this publication.

V5850-561-00 06/08

MTN5812../MTN5860..
MTN5840..

Time switch

Operating instructions

System M

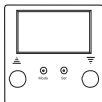

Time switch

Art. no. MTN5812../MTN5860..

Artec/Tracent/Antique

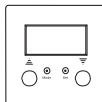

Time switch

Art. no. MTN5840..

Table of contents

Accessories	3	Resetting or changing switching times	17
Getting to know the time switch	3	Deleting switching times	20
Connections, displays and operating elements	4	Astro time shift programming	21
Wiring the insert	5	Resetting	22
Mounting the time switch	5	What should I do if there is a problem?	23
Functions	6	Technical data	23
Program memories and switching times	4	Appendix 1 – Local time deviation	25
Random function	5	Appendix 2 – Your switching times	26
Astro function	5		
Astro time shift	6		
Behaviour during mains voltage failure/power reserve	7		
Starting up the time switch	10		
Switching loads on/off manually	10		
Activating program memories	10		
Using the timer function	11		
Switching on loads with the timer function	11		
Setting the timer start time	12		
Toggling summer/winter time	13		
How set mode works	14		
Setting the date/time	15		

Accessories

To be completed with a frame that matches the switch design.

Getting to know the time switch

The time switch is delivered as a complete device with a flush-mounted insert for mounting the time switch. You can set the time switch to switch electrical loads such as lamps (see technical data for insert) on and off at specific times. Using the two extension inputs, you can also switch loads with mechanical push-buttons (make contacts).

Product features:

- Simple operation using four push-buttons
- Two independent program memories for a total of up to 18 switching times
- Switching times pre-set at the factory, but can be changed later
- Reset (restore default settings)
- Toggle from summer to winter time by pressing a button
- Timer function
- Random function
- Astro function (control by astronomic pre-calculation of sunrise and sunset)
- Adjustment of astro function by individual astro time shift

- Power reserve and retention of set switching times during power failure
- Can be operated with extension unit

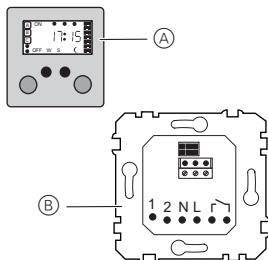

Fig. 1: Time switch with insert

(A) Time switch

(B) Flush-mounted insert for time switch

Connections, displays and operating elements

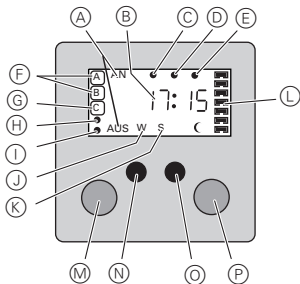

Fig. 2: Time switch display and operating elements

- (A) Connected load "ON" or "OFF"
- (B) Hours and minutes (flash if the time has not yet been set)
- (C) Set mode
- (D) Random function
- (E) Astro function
- (F) Active program memory
- (G) Timer function (on program memory [C])
- (H) Setting the time
- (I) Setting the date
- (J) Winter time
- (K) Summer time
- (L) Day of the week
- (M) "Switch on" or "Forward" (in set mode)

- (N) "Mode"; selection and deselection of various functions
- (O) "Set"; setting and confirming functions
- (P) "Switch off" or "Back" (in set mode)

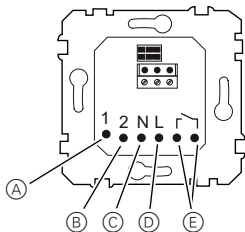

Fig. 3: Insert connections for time switch

- (A) Extension unit off
- (B) Extension unit on
- (C) Neutral conductor
- (D) Phase
- (E) Floating relay

i The floating relay is not suitable for safety isolation.

Wiring the insert

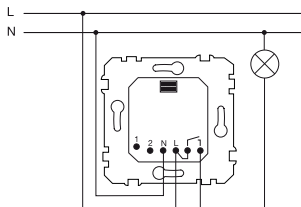

Fig. 4: Connection to a phase

- ① Connect phase L to input relay.

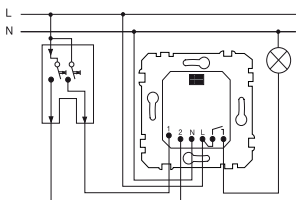

Fig. 5: Connection to a dual push-button

- ② Connection as for single-phase, connect dual push-buttons to both extension inputs

Mounting the time switch

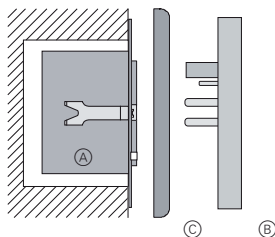

Fig. 6: Connection to a phase

- ① Fasten attachment (B) complete with frame (C) to insert (A).

Functions

Program memory and switching times

The time switch has three program memories: [A], [B] and [C]. After installation and reset, program memories [A] and [B] feature standard switching times, which can be altered at any time. [C] includes the timer function (see „Using the timer function“, p. 11). If none of these memories is activated, the time switch operates in manual mode.

Program memory [A]

1. Mon - Fri 7:00 a.m. switch off (OFF), astro function on
2. Sat - Sun 9:00 a.m. switch off (OFF), astro function on
3. Mon - Fri 8:00 p.m. switch on (ON), astro function on
4. Sat - Sun 9:00 p.m. switch on (ON), astro function on

Program memory [B]

1. Mon - Fri 7:00 a.m. switch off (OFF)
2. Sat - Sun 9:00 a.m. switch off (OFF)
3. Mon - Fri 8:00 p.m. switch on (ON)
4. Sat - Sun 9:00 p.m. switch on (ON)

Program memory [C] – timer

The timer function factory setting is 15 min („Setting the timer start time“, p. 12).

When you activate the required program memory, the switching times saved in it are executed in sequence.

You can modify or delete the switching times in memories [A] and [B] as required, save additional switching times (up to a total of 18) (see „Setting new switching times/modifying switching times“, p. 17) or delete them (see „Deleting switching times“, p. 20).

Setting a switching time includes:

- the time switch switching behaviour (switching on or off)
- the start time (to the minute)
- the day of the week (one, several or all)
- random function on or off
- astro function on or off

During a reset, the set switching times are deleted and reset to the default values.

Random function

This enables you to give any external observer the impression that you are constantly at home. The random function uses an integrated random generator to vary the times you set by between -15 minutes and +15 minutes every day.

You can switch the random function on or off individually for each switching time.

For example:

Random time +9 min

Switching time 1: Switch off at 7:00 a.m., random function on: The lighting is switched off at 7:09 a.m..

Switching time 2: Switch on at 8:00 p.m., random function off: The lighting is switched on at 8:00 p.m.

You can combine the astro function with the random generator for each individual switching time. Then this switching time is adapted to the current sunrise or sunset time, and then extra variation is added by the random generator.

Astro function

The **astro function** means that your lighting can be switched on or off at the actual times of sunrise or sunset, rather than at a pre-set switching time.

The time switch also contains an integrated astronomical calendar that calculates the sunrise and sunset for every day of the year.

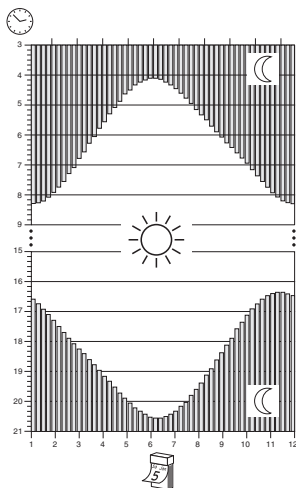

Fig. 7: Astronomical calendar for sunrise and sunset

You can switch the astro function on or off individually for each switching time.

On astro function, when the time switch calculates that at a certain switching-on time it will still be dark outside, the lighting will not be switched off until the actual moment of sunrise.

Likewise, when the time switch has calculated that at a switching-off time set for the astro function it will still be light outside, the lighting will only be switched on at the actual time of sunset.

Other switching times set for daylight hours are not affected by the astro function.

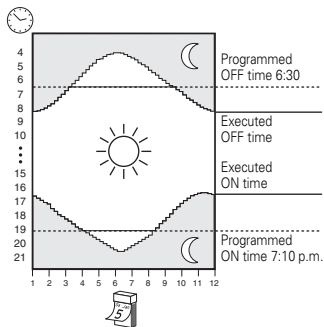

Fig. 8: Astro function (application)

Astro time shift

The integrated astronomical calendar is designed for the centre of the CET time zone. To adapt the astro function to your longitudinal location, individually and to the second, you can use the **astro time shift** to correct the astro times calculated by the time switch, by $\pm 1:59$ hrs. (see „Programming the astro time shift“, p. 21).

Astro function - application examples

Example 1:

The lighting should be switched off every day at sunrise:

- Switching time 1: Mon - Sun 04:00 a.m. switch off, astro function on and switch on at sunset:
- Switching time 2: Mon - Sun 4:00 p.m. switch on, astro function on

Example 2:

The lighting should be switched off in the morning at sunrise, if sunrise is before 6:30 a.m. in winter, but no later than 6:30 a.m.:

- Switching time 1: Mon - Sun 6:30 a.m. switch off, astro function on and in the evening should switch on at 7:10 p.m. at the earliest, or later at sunset, when this is later than 7:10 p.m. in winter:
 - Switching time 2: Mon - Sun 7:10 p.m. switch on, astro function on
- In winter, when it is still dark outside at 6:30 a.m., the astro function intervenes, and the lighting only switches off at the current time of sunrise. In winter, it is already dark before 7:10 p.m., so the astro function causes the lighting to be switched on earlier, at the actual time of sunset.

However, in summer, when the actual time of sunrise is before 6:30 a.m., the astro function does not intervene, and the lighting is switched off at 6:30 a.m.. The switching-on time follows suit.

Example 3:

The lighting should be switched off in the morning at exactly 6.30 a.m.:

- Switching time 1: Mon - Sun 6:30 a.m. switch off, astro function off and in the evening, should always switch on at sunset:

- Switching time 2: Mon - Sun 4:00 p.m. switch on, astro function on



If you set a switching-on time in the morning (without astro function), it be a time when it is dark all year round, i.e. before 4:00 a.m.

Behaviour during mains voltage failure/power reserve

When the mains voltage fails, the display -- : -- appears briefly, then goes out. The switching times that you have configured, as well as your time/date and other settings are retained for a period of approximately 24 hrs. (power reserve, no batteries required).

After mains voltage recovery, the switching time of the active program memory [A] or [B] that was last activated before the mains voltage recovery is executed. This means that the load is controlled as it should be according to the set switching times. The most recent "missed" switching time is made good.

For example:

Switching time 3: 8:15 p.m. switch on,
Mains voltage failure: 8:10 p.m.,
Mains voltage recovery: 8:20 p.m.,
Switching time 3 is executed, and the lighting is switched on.

When a mains voltage failure lasts for more than 24 hours, the switching times, time/date and other settings that you have individually set are lost and must be reset. When recommissioned, the time switch is automatically reset to its standard values.

Starting up the time switch

The time switch is operational when the mains voltage is switched on. The time display flashes.

First perform a reset in order to delete all data and restore the device to factory settings.

- ① Press the **[Mode]** and **[Set]** buttons simultaneously for about 7 seconds, until all symbols in the display go out.

The reset is completed and the factory settings are loaded (see „Program memory and switching times“, p. 6).

Now program the date and time (see „Setting the date and time“, p. 15).

Switching loads on/off manually

You can also switch loads on or off manually, regardless of programmed switching times or sun protection functions.

- Switching on: Press the **[EIN]** (ON) button.
- Switching off: Press the **[AUS]** (OFF) button.

Loads can also be operated by an extension input (see insert manual).



Manual or automatic switching via the time switch is disabled while the extension unit is in use.

Activating program memories

As described in „Program memory and switching times“, p. 6, you can save up to 18 switching times, shared as required between program memories [A] or [B]. Program memory [C] is dedicated to the timer function (see „Using the timer function“, p. 11).

To activate a program memory and the switching times it contains:

- ① Press **[Mode]** until the symbol for the required program memory [A] or [B] appears in the display.

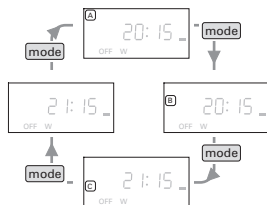

Fig. 9: Activating program memories

When program memory [C] (timer) is activated and you press **[Mode]** again, **none** of the three program memory symbols appears. This deactivates the program memories and the lighting does not react to switching times. It only operates in manual mode (see „Switching loads on/off manually“, p. 10). You can use this feature, for example, to prevent the lighting from automatically switching on when it is not wanted, e. g. for a garden party.

Using the timer function

You can use the timer function to switch on an electrical load for a pre-set period. The load is switched off again once the time set has expired.

The default start time is 15 minutes, but you can set the start time from 1 min. to 1:59 hrs yourself.

The timer function is integrated into program memory [C].

Switching on loads with the timer function

- 1 Press **[Mode]** until program memory [C] flashes in the display.



Fig. 10: Switching on the timer function

The last start time that was set on the timer appears (e.g. 15 min, Fig. 10).

- 2 Briefly press the **[EIN]** (ON) button (max 1 s).

The load is switched on. The timer function starts. The timer period counts down. The colon between the hour and minute displays flashes.

When the timer period reaches 00:00 the load switches off, and the pre-set time is again shown as the timer start time.

You can intervene to stop the countdown and switch off the load at any time:

- 3 Press the **[AUS]** (OFF) button.

The load switches off, and the pre-set time is again shown as the timer start time.

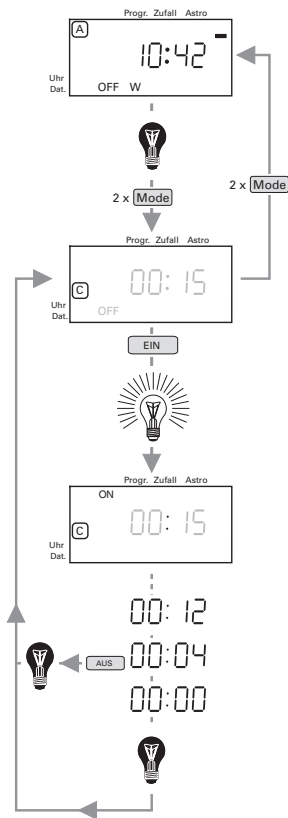

Fig. 11: Switching on lighting with the timer function

Setting the timer start time

The timer start time is pre-set to 15 min..

- Press **[Mode]** until program memory **[C]** flashes in the display.



Fig. 12: Timer function

The last start time that was set on the timer appears (e.g. 15 min, Fig. 10).

- Hold down (for at least 1 s) **[EIN]** (ON) or **[AUS]** (OFF) to set the desired timer start time (00:01–23:59):

- **[EIN]** (ON) = increase start time
- **[AUS]** (OFF) = reduce start time

The timer start time initially changes in steps of one minute. These steps become longer, the longer the button is pressed down.

When you have set the desired timer start time:

- Press and hold down the **[Mode]** button for at least 3 seconds.

The timer start time flashes. When the display stops flashing and lights steadily, the new timer start time has been saved and you can release the **[Mode]** button.

- i** Switching times will not be executed while you are setting the timer start time.

Toggling summer time/ winter time

You can change the time on the device to summer or winter time.

- ① Briefly press the **[Set]** button to toggle between:
 - Winter time **W**
 - Summer time **S**

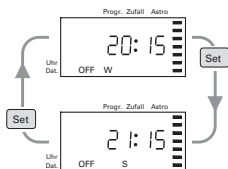

Fig. 13: Toggling summer time/winter time

How set mode works

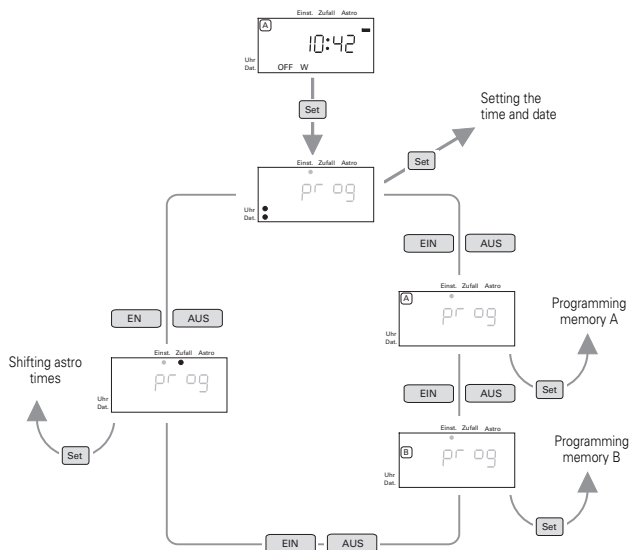

Fig. 14: Set mode

All functions can be selected and adjusted as you require using set mode.

Set mode is operated with four buttons:

- [**Set**] Open set mode, confirm a selection
- [**Mode**] Select and deselect various functions
- [**EIN**] (ON) Scroll forwards
- [**AUS**] (OFF) Scroll backwards

From the basic display (current time), press and hold the [**Set**] button until **prog** appears in the display. The time switch is now in set mode for "Time/Date" (flashing light next to "Uhr/Dat." (Time/Date)).

You can scroll back and forth between the various setting options using the [**EIN**] (ON) and [**AUS**] (OFF) buttons. The corresponding symbol flashes in the display.

Press [**Set**] again when the setting you want to change is shown. You can now change the settings (see following sections).

i If you wait longer than 2 min to press any button in set mode, the device switches back to the basic display. Any changes made up to then will be saved.

You can exit set mode at any time by pressing and holding the [**Set**] button for about 3 sec. Any changes made up to then will **not** be saved!

Tip: You can select some values more quickly by holding [**EIN**] (ON) and [**AUS**] (OFF) down longer. After a short time, the values will start to change in larger steps.

Setting the date and time

- ① Press and hold the [**Set**] button until **prog** appears in the display.

The device is now in set mode. The "Set date and time" lights flash on the display.

- ② Press the [**Set**] button.
- ③ Press [**EIN**] (ON) or [**AUS**] (OFF) to set summer time (**S**) or winter time (**W**).
- ④ To confirm, press [**Set**].

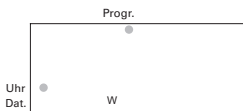

Fig. 15: Setting summer time/winter time

- ⑤ Press [**EIN**] (ON) or [**AUS**] (OFF) to set the current month (**01**–**12**).
- ⑥ To confirm, press [**Set**].



Fig. 16: Setting the month

- ⑦ Press **[EIN]** (ON) or **[AUS]** (OFF) to set the current date (01–31).
- ⑧ To confirm, press **[Set]**.



Fig. 17: Setting the date

- ⑨ Press **[EIN]** (ON) or **[AUS]** (OFF) to set the current day of the week (Mon–Sun).
- ⑩ To confirm, press **[Set]**.



Fig. 18: Setting the day of the week

- ⑪ Press **[EIN]** (ON) or **[AUS]** (OFF) to set the current time in hours (00–23).
- ⑫ To confirm, press **[Set]**.



Fig. 19: Setting the hours

- ⑬ Press **[EIN]** (ON) or **[AUS]** (OFF) to set the current time in minutes (00–59).
- ⑭ To confirm, press **[Set]**.



Fig. 20: Setting the minutes

The date and time are now saved. The basic display (time) appears.

Setting new switching times/modifying switching times

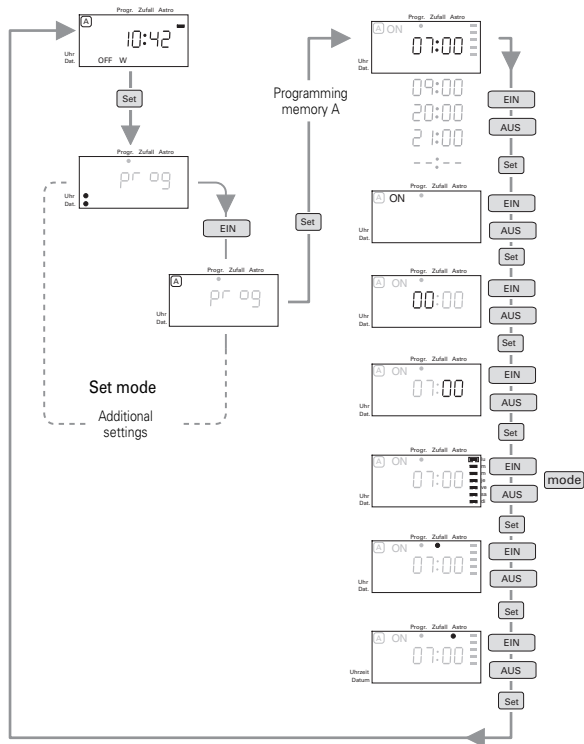

Fig. 21: Setting switching times

Fig. 21 illustrates an example of how a switching time is set for program memory [A].

You can set new switching times (max. 18) or modify previously saved switching times (for how to delete them, see „Deleting switching times“, p. 20).

If the same time on the same day of the week is set for both an "on" time and an "off" time, the switching-off time is the one that is executed.

Activating set mode

- ① Press and hold the **[Set]** button until **prog** appears in the display.

The device is now in set mode. The "Set date and time" lights flash on the display.

Selecting the program memory

- ② Press **[EIN]** (ON) or **[AUS]** (OFF) until the symbol for the required program memory [A] or [B] flashes.
- ③ To confirm, press **[Set]**.

The switching time set mode is now active.

Selecting a switching time

If switching times have already been saved in this program memory, the first is now shown, and flashes. Otherwise – – : – – is shown (empty memory slot).

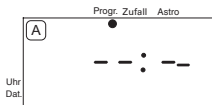

Fig. 22: Empty memory slot

- ④ Press **[EIN]** (ON) or **[AUS]** (OFF) to scroll between the saved switching times and select the one you require.
- ⑤ To confirm the memory slot, press **[Set]**.

You can now modify the saved switching time, or set a new switching time in the empty memory slot.

Setting loads On or Off

- ⑥ Press **[EIN]** (ON) or **[AUS]** (OFF) to set the load to be switched ON or OFF at the relevant time.
- ⑦ To confirm, press **[Set]**.

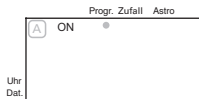

Fig. 23: Switching a load on or off

Setting the time

- ⑧ Press **[EIN]** (ON) or **[AUS]** (OFF) to set the time in hours when the lighting should be switched.
- ⑨ To confirm, press **[Set]**.



Fig. 24: Setting the hour

- ⑩ Press **[EIN]** (ON) or **[AUS]** (OFF) to set the time in minutes.
- ⑪ To confirm, press **[Set]**.



Fig. 25: Setting the minutes

Setting the day(s) of the week

You can also set on which day(s) of the week the switching time should be executed.

Each active day of the week is represented by a small bar.

Bar shown = Switching time will be carried out on this day.

Bar hidden = Switching time will not be carried out on this day.

A flashing frame around a bar shows that you can now select or deselect this day of the week.

- ⑫ Press **[EIN]** (ON) or **[AUS]** (OFF) to move this selection frame.
- ⑬ Press the **[Mode]** button to select or deselect the day marked by the frame.

When you have finished selecting or deselecting days:

- ⑭ To confirm, press **[Set]**.



Fig. 26: Choosing days of the week

Switching on the random function

You can determine whether or not the random function should be activated for this switching time (see „Random function“, p. 7).

If the symbol (see Fig. 27) is shown, the random function is currently switched on

If the symbol is flashing, it means the random function is switched off

- ⑮ Press **[EIN]** (ON) or **[AUS]** (OFF) to switch the random function on or off.
- ⑯ To confirm, press **[Set]**.



Fig. 27: Activating the random function

Switching on the astro function

You can set whether or not the astro function should be switched on for this switching time (see „Astro function“, p. 7).

⑰ Symbol (see Fig. 28) displayed = astro function is currently switched on

Symbol flashing = astro function is switched off

⑱ Press **[EIN]** (ON) or **[AUS]** (OFF) to switch the astro function on or off.

⑲ To confirm, press **[Set]**.



Fig. 28: Switching on the astro function

Completing settings

The switching time is now saved. If other switching times were already stored in this program memory, the new or modified switching time will be added in chronological order.

The time switch is still in switching time set mode. Continue as described under "Selecting a switching time" if you want to carry out settings for further switching times in this program memory.

To return to the basic display:

⑳ Press and hold **[Set]** until the basic display (current time) is shown.

Deleting switching times

Selecting the program memory

First select the program memory which contains the switching time that you want to delete:

① Press and hold the **[Set]** button until **prog** appears in the display.

The device is now in set mode. The "Set date and time" lights flash on the display.

② Press **[ON]** or **[OFF]** until the symbol of program memory [A] or [B] in which the switching time is to be deleted flashes.

③ To confirm, press **[Set]**.

The switching time set mode is now active.

If there are any switching times saved in this program memory, the first is now shown, and flashes. Otherwise -- : -- is shown (empty memory slot).

④ Press the **[ON]** or **[OFF]** buttons to view the switching time to be deleted.

⑤ To delete the switching time, press and hold the **[Mode]** button until -- : -- is displayed.

The switching time is now deleted. You can now delete other switching times in this program memory in the same way.

To return to the basic display:

- ⑥ Press and hold **[Set]** until the basic display (current time) is shown.

Programming the astro time shift

The integrated astro function is preset with the times for sunrise and sunset in central Europe (CET). If your location is far east or west of this imaginary central line, you can precisely compensate for the resulting time shift for sunrise and sunset separately.

Example: You have configured the load/lighting to be switched on at sunset, i.e. with the astro function. The lighting thus switches on at the calculated time of sunset, at 8:53 p.m. But since your own location is not in the centre of your time zone (e.g. Munich, which is CET minus 14 minutes), the sun actually sets where you are at 8:39 p.m. You need to set an astro time shift of -14 min, so that the lighting will be switched on at 8:39 p.m. in the future, i.e. 14 minutes earlier than time calculated by the astro function.

See also „Appendix 1 – Local time deviation“, p. 25.

- ① Press and hold the **[Set]** button until **prog** appears in the display.

The device is now in set mode. The "Set date and time" lights flash on the display.

- ② Press **[ON]** or **[OFF]** until the light underneath "Astro" in the display flashes or lights up steadily.
- ③ To confirm, press **[Set]**.

The astro time shift set mode is now active.



Fig. 29: Astro time shift

Tip: The time shift from CET is less than an hour throughout continental Europe, with the exception of Spain. To go directly to setting minutes, press **[Set]**.

Entering the time shift in hours for sunrise (ON):

- ① Press the **[ON]** or **[OFF]** buttons to select the time shift in hours:
 - 1 moves the astro times back one hour
 - 1 moves the astro times forward one hour
- ② To confirm, press **[Set]**.

Entering the time shift in minutes for sunrise:

- Press **[ON]** or **[OFF]** to set the minutes (00–59) by which the astro times should be moved forward ("0") or back ("-0").
- To confirm, press **[Set]**.

Entering the time shift in hours for sunset (OFF):

- Press **[ON]** or **[OFF]** to select the time shift in hours:
 - 1 moves the astro times back one hour
 - 1 moves the astro times forward one hour
- To confirm, press **[Set]**.

Entering the time shift in minutes for sunset:

- Press **[ON]** or **[OFF]** to set the minutes (00–59) by which the astro times should be moved forward ("0") or back ("-0").

Saving the astro time shift

- Press and hold **[Set]** until the basic display (current time) is shown.

The astro time shift is now saved, and will be automatically activated for all switching times that use the astro function.

The basic display (time) appears.

Resetting



CAUTION

Resetting deletes all switching times and settings and the default settings are restored.

- Press the **[Mode]** and **[Set]** buttons simultaneously for about 7 seconds, until all symbols in the display go out.

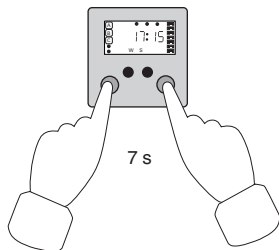

Fig. 30: Resetting

The reset is completed and the factory settings are loaded (see „Program memory and switching times“, p. 6).

What should I do if there is a problem?

This section describes apparent and possible faults, and the options for eliminating them. If the problem with your device is not listed here, please contact our Infoline (see reverse).

The lighting switches on or off for no apparent reason.

- It may be that the lighting is being manually operated through an extension unit (see insert manual).
- The timer function may have finished.

While the astro function is activated, the lighting switches at times that deviate significantly from the actual times of sunrise or sunset.

- Check that you have set the date and astro time shift (see „Astro function", p. 7) correctly.
- Check whether you have activated winter time instead of summer time, or vice versa (see „Toggling summer time/winter time", p. 13).

The lighting does not react when buttons are pressed.

A switch command may be activated on the insert extension input (see „Switching loads on/off manually", p. 10).

Technical data

Insert

Nominal voltage: AC 230 V, 50 Hz

Switching capacity

Incandescent lamps: 1000 W

lamps:

HV halogen lamps: 1000 W

LV halogen lamps

With electr.

transformer: 750 W

With conv.

transformer: 750 VA (min. 85 % nominal load)

Fluorescent lamps

Uncompensated: 500 VA

Parallel-

compensated: 400 VA (47 μ F)

Lead-lag

connection: 1000 VA

Energy-saving

lamps: be aware of high switch-on peaks!
Check electrical data of the load in advance

Relay output: 1 floating make contact

Switch time interval: min. 1 min.

Connecting

terminals: Screw terminals, max. 2.5 mm² or 2 x 1.5 mm²

Circuit breaker: max. 16 A

Neutral conductor required

Time switch

Accuracy:	± 1 min/month
Reserve power:	approx. 24 hours (no battery required)
Program memory:	2
Switching times:	max. 18
Timer function:	1 min. - 23:59 hours
Random generator:	± 15 min
Astro program:	can be shifted by $\pm 1:59$ hrs.
Standard movement time:	approx. 2 min (adjustable)
Connection:	on insert for time switch

Appendix 1 – Local time deviation

City	Degree of longitude (approx.)	Astro time shift
Warsaw	21° east	+24 min.
Budapest	19° east	+16 min.
Vienna	16° 30' east	+6 min.
Goerlitz	15° east	0 min.
Berlin	13° 30' east	-6 min.
Munich	11° 30' east	-14 min.
Schwerin	11° 30' east	-14 min.
Hamburg	10° east	-20 min.
Frankfurt/Main	7° 45' east	-29 min.
Aachen	6° east	-36 min.
Amsterdam	5° east	-40 min.
Brussels	4° 20' east	-43 min.
Paris	2° 20' east	-50 min.
Madrid	3° 35' west	-74 min.

The table which follows tells you by how many minutes your local time deviates from standard time (Central European Time **CET**). This deviation represents your astro time shift.



When operating the blind time switch in countries that are not on CET, you must determine the deviation of your local time from the time in the relevant zone yourself.

Rule-of-thumb: 1 degree of longitude corresponds to a deviation of 4 minutes.

Appendix 2 – Your switching times

You can use this page to note the switching times and settings that you have configured:

Program memory [A]				
On/Off	Time	Days of the week	Random function	Astro function

Program memory [B]				
On/Off	Time	Days of the week	Random function	Astro function

Astro time shift:

